



*makes your job easier*

# **T-REX17<sup>®</sup> SCREW SERIES**

---

## **PRODUCT CATALOGUE**

# T-REX17<sup>®</sup> Batten Screws

Bugle Head, Hex Drive - OutDoor XGuard, 316 Stainless Steel

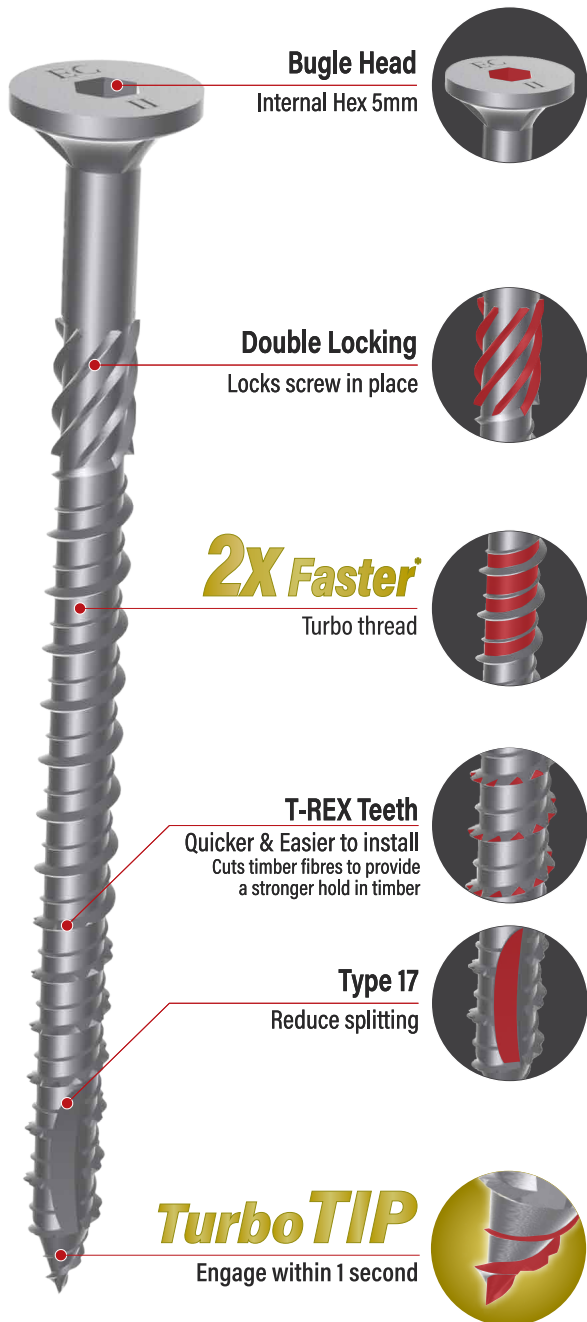

**DRIVE**



Internal Hex Drive

**DRIVER BIT**



Included in each packet

**FINISH**



Outdoor Use



Outdoor / Sea Spray Zone Use

**ECKO-FRIENDLY PACKAGING**  
Recyclable



**TUB**



\*Please refer to the technical specification for fastener requirements or installation manual for each specific application you are working with.

# T-REX17® Batten Screws

Bugle Head, Hex Drive - OutDoor XGuard, 316 Stainless Steel

OutDoor XGuard - Outdoor Use				
Diameter	Length (mm)	Product Code	PCS / Pack	Pack / Outer
14G	50	BBC414G50L-25	25	6
		BBC414G50L-100	100	5
	65	BBC414G65L-25	25	6
		BBC414G65L-100	100	5
	75	BBC414G75L-25	25	6
		BBC414G75L-100	100	5
		BBC414G75L-250	250	4
		BBC414G75L-500	500	1
	90	BBC414G90L-25	25	6
		BBC414G90L-100	100	5
		BBC414G90L-250	250	4
		BBC414G90L-500	500	1
	100	BBC414G100L-25	25	6
		BBC414G100L-100	100	5
		BBC414G100L-250	250	4
		BBC414G100L-500	500	1
		BBC414G100TUB-500	500	1
		BBC414G125L-25	25	6
	125	BBC414G125L-100	100	5
		BBC414G125L-250	250	4
		BBC414G125L-500	500	1
		BBC414G125TUB-450	450	1
		BBC414G150L-25	25	6
	150	BBC414G150L-100	100	5
		BBC414G150L-250	250	4
		BBC414G150L-500	500	1
		BBC414G200L-25	25	6
	200	BBC414G200L-100	100	5
316 Stainless Steel - Outdoor & Sea Spray Zone Use				
Diameter	Length (mm)	Product Code	PCS / Pack	Pack / Outer
14G	75	BBSS14G75-25	25	6
		BBSS14G75-100	100	5
		BBSS14G75-250	250	4
		BBSS14G75-500	500	1
	90	BBSS14G90-25	25	6
		BBSS14G90-100	100	5
		BBSS14G90-250	250	4
		BBSS14G90-500	500	1
	100	BBSS14G100-25	25	6
		BBSS14G100-100	100	5
		BBSS14G100-250	250	4
		BBSS14G100-500	500	1
	125	BBSS14G125-25	25	6
		BBSS14G125-100	100	5
		BBSS14G125-250	250	4
		BBSS14G125-500	500	1
	150	BBSS14G150-25	25	6
		BBSS14G150-100	100	5
		BBSS14G150-250	250	4
		BBSS14G150-500	500	1



**TurboTIP**  
Instant engage!

### TurboTIP - Instant Engagement, Maximum Speed

Experience exceptional efficiency with **TurboTIP** - engineered to engage within 1 second, delivering immediate bite and superior grip every time. Say goodbye to frustrating delays and stripped starts - **TurboTIP** ensures a quick, clean, and effortless start, making it the ultimate solution for faster, smoother installations.

**TurboTIP** - Engage Instantly. Drive with Confidence.

# T-REX17<sup>®</sup> Batten Screws

Bugle Head, TX Drive - 304 Stainless Steel

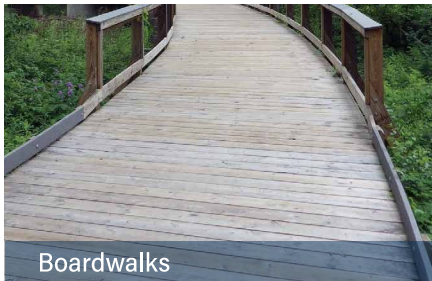
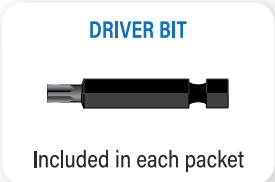
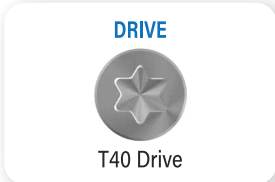
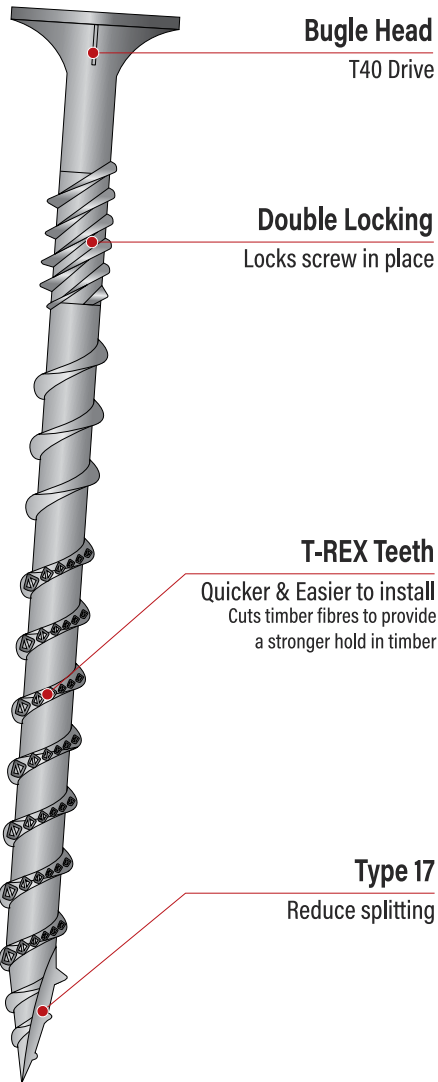

Boardwalks



Pergolas



Retaining walls

\*Please refer to the technical specification for fastener requirements or installation manual for each specific application you are working with.

304 Stainless Steel - Outdoor & Sea Spray Zone Use					
Diameter	Length (mm)	Product Code	Drive	PCS / Pack	Pack / Outer
14G	75	BB30414G75-25	T40 Drive	25	6
		BB30414G75-100	T40 Drive	100	5
	100	BB30414G100-25	T40 Drive	25	6
		BB30414G100-100	T40 Drive	100	5
	125	BB30414G125-25	T40 Drive	25	6
		BB30414G125-100	T40 Drive	100	5

# Bugle Head Deep Drilling Screws

Bugle Head, TX Drive - C4 Galvanised

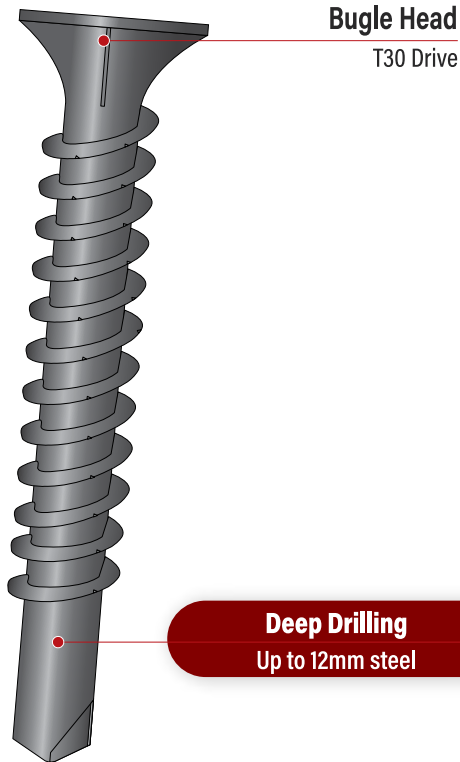

**DRIVE**



T30 Drive

**DRIVER BIT**



Included in each packet

**FINISH**



Outdoor Use

**APPLICATION**



Metal

**ECKO-FRIENDLY PACKAGING**  
Recyclable





\*Please refer to the technical specification for fastener requirements or installation manual for each specific application you are working with.

C4 Galvanised - Outdoor Use					
Diameter	Length (mm)	Product Code	Drive	PCS / Pack	Pack / Outer
14G	50	BHC4S14G50-100	T30 Drive	100	6
	75	BHC4S14G75-100	T30 Drive	100	5
	100	BHC4S14G100-100	T30 Drive	100	5

# T-REX17® JoltScrew

Jolt Head, TX Drive - OutDoor XGuard

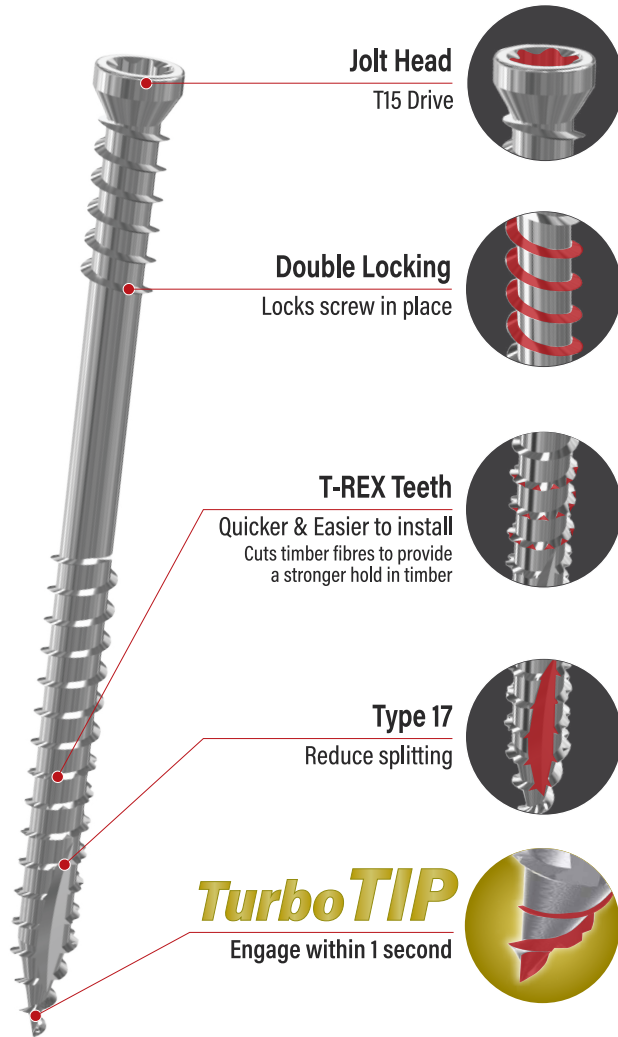
**DESIGNED WITH  
PRECISION AND INNOVATION**



### Jolt Head

T15 Drive



### Double Locking

Locks screw in place

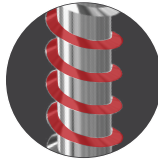

### T-REX Teeth

Quicker & Easier to install  
Cuts timber fibres to provide a stronger hold in timber

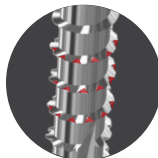

### Type 17

Reduce splitting

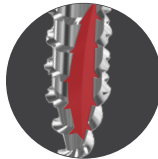

### Turbo TIP

Engage within 1 second

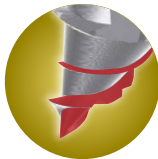

### DRIVE



T15 Drive

### DRIVER BIT



Included in each packet

### FINISH



Outdoor Use

### ECKO-FRIENDLY PACKAGING

Recyclable



Jolt Head - A small head (5mm) for applications where the head is required to be concealed

### ENDORSED / SPECIFIED BY

Southern Pine Products  
Hume Pine  
Niagara  
OTC Timber

### TUB

OutDoor XGuard  
8G x 75mm  
2000pcs  
CODE: WDJC48G75TUB-2K



Weatherboard

Windows

Door frame

\*Please refer to the technical specification for fastener requirements or installation manual for each specific application you are working with.

OutDoor XGuard - Outdoor Use					
Diameter	Length (mm)	Product Code	Drive	PCS / Pack	Pack / Outer
8G	40	WDJC48G40-100	T15 Drive	100	6
	40	WDJC48G40-500	T15 Drive	500	5
	50	WDJC48G50-100	T15 Drive	100	6
	50	WDJC48G50-500	T15 Drive	500	5
	65	WDJC48G65-100	T15 Drive	100	6
	65	WDJC48G65-500	T15 Drive	500	5
	75	WDJC48G75-100	T15 Drive	100	6
	75	WDJC48G75-500	T15 Drive	500	5
	75	WDJC48G75TUB-2K	T15 Drive	2000	1
	90	WDJC48G90-250	T15 Drive	250	5

# T-REX17® JoltScrew

Jolt Head, TX Drive - 316 Stainless Steel

**DESIGNED WITH  
PRECISION AND INNOVATION**

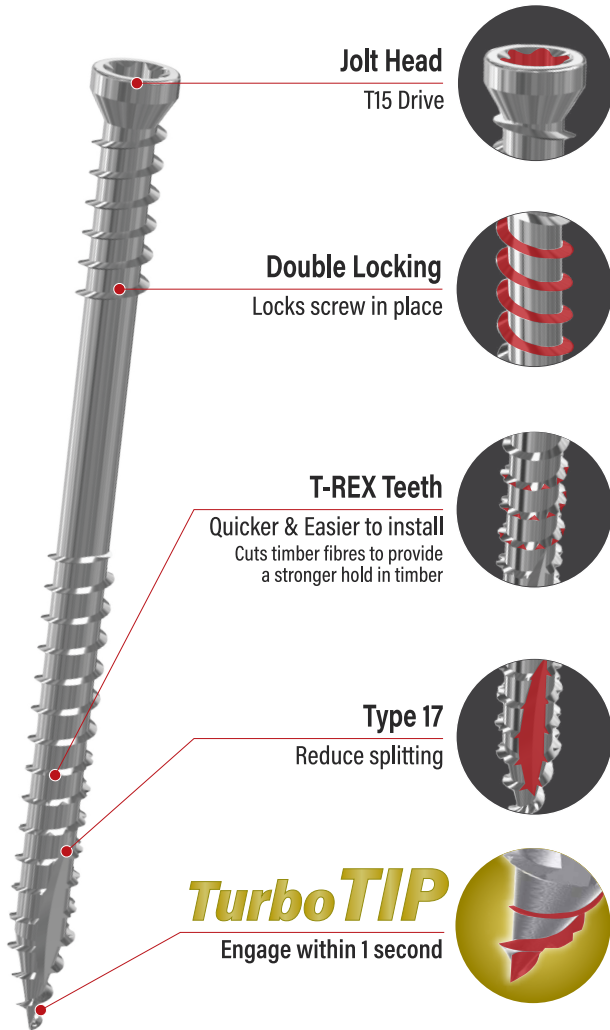

**Jolt Head**

T15 Drive

**Double Locking**

Locks screw in place

**T-REX Teeth**

Quicker & Easier to install  
Cuts timber fibres to provide a stronger hold in timber

**Type 17**

Reduce splitting

**Turbo TIP**

Engage within 1 second

**DRIVE**



T15 Drive

**DRIVER BIT**



Included in each packet

**FINISH**



Outdoor / Sea  
Spray Zone Use

**ECKO-FRIENDLY PACKAGING**  
Recyclable



Jolt Head - A small head (5mm) for applications where the head is required to be concealed

**ENDORSED / SPECIFIED BY**

Southern Pine Products  
Hume Pine  
Niagara  
OTC Timber

## HOLDING POWER

JoltScrew has 6x more holding power than Jolt Head Nail

Fixing Type	Withdraw in pine - 31mm penetration (LPL - kN)	Head pull through in weatherboard 19mm thick (LPL - kN)
JoltScrew 316 S/Steel 8g x 75mm	3.89	1.48
JoltScrew 316 S/Steel 8g x 90mm	5.29	1.48
Jolt Head Nail 75 x 3.15mm	0.66	0.56
Jolt Head Nail 60 x 2.80mm	0.54	0.32

316 Stainless Steel - Outdoor & Sea Spray Zone Use

Diameter	Length (mm)	Product Code	Drive	PCS / Pack	Pack / Outer
8G	65	WDJ3168G65-100	T15 Drive	100	6
	65	WDJ3168G65-500	T15 Drive	500	5
	75	WDJ3168G75-100	T15 Drive	100	6
	75	WDJ3168G75-500	T15 Drive	500	5
	90	WDJ3168G90-250	T15 Drive	250	5

# T-REX17® JoltScrew

Jolt Head, TX Drive - 316 Stainless Steel Bronze

**DESIGNED WITH  
PRECISION AND INNOVATION**

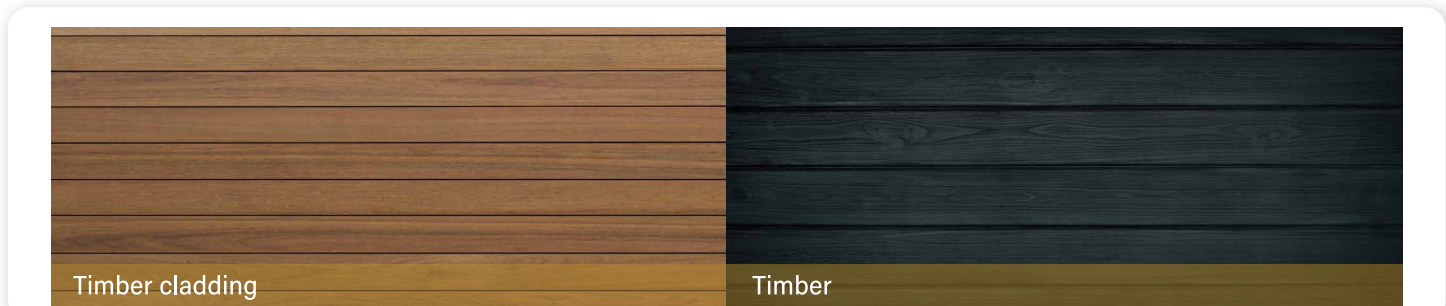
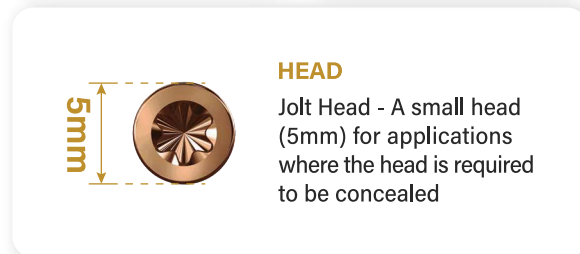
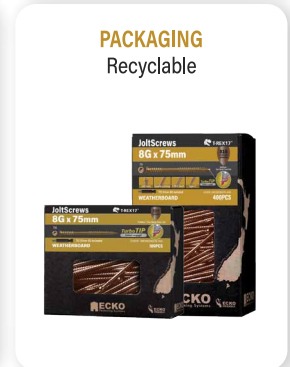
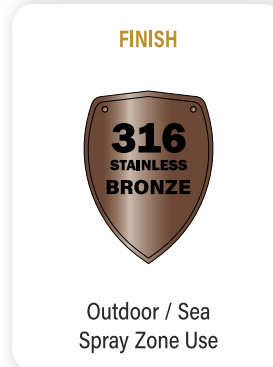
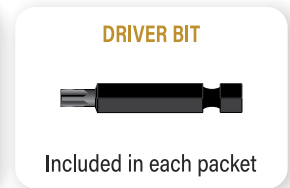
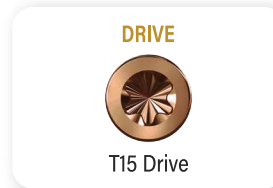
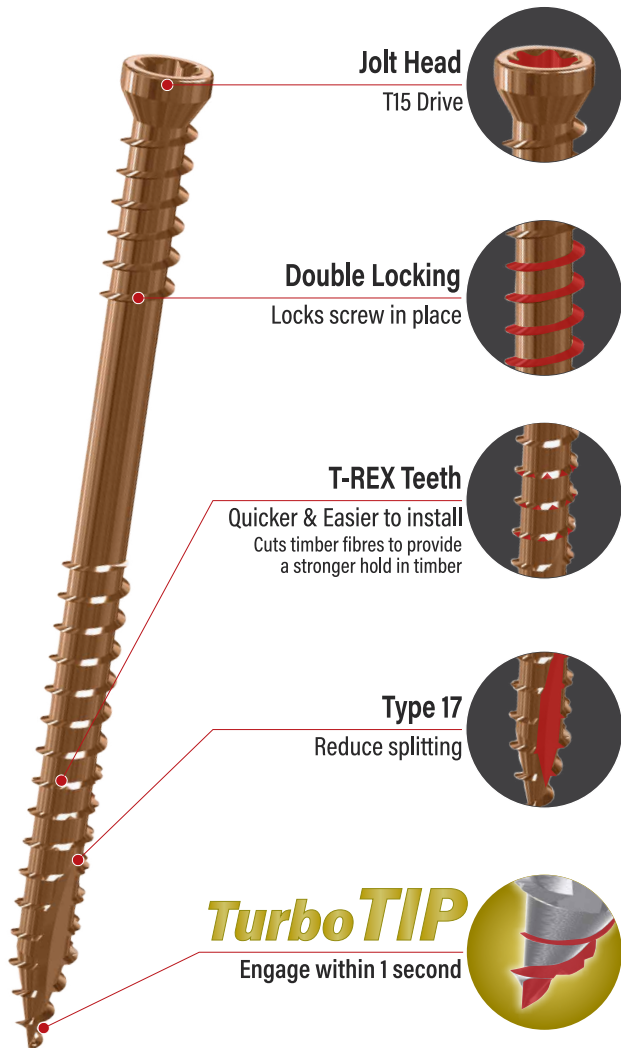

\*Please refer to the technical specification for fastener requirements or installation manual for each specific application you are working with.

316 Stainless Steel Bronze - Outdoor & Sea Spray Zone Use					
Diameter	Length (mm)	Product Code	Drive	PCS / Pack	Pack / Outer
8G	75	WDJBZ8G75-100	T15 Drive	100	6
	75	WDJBZ8G75-400	T15 Drive	400	5

# T-REX17® JoltScrew

Jolt Head, TX Drive - 316 Stainless Steel Black

**DESIGNED WITH  
PRECISION AND INNOVATION**

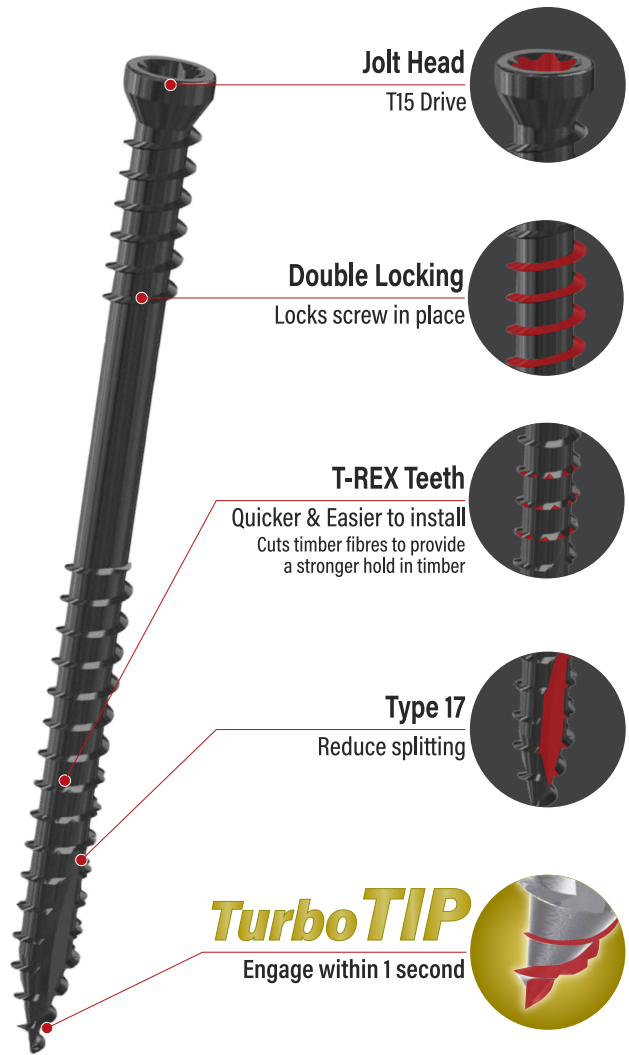

**DRIVE**



T15 Drive

**DRIVER BIT**



Included in each packet

**FINISH**



Outdoor / Sea  
Spray Zone Use

**PACKAGING**

Recyclable



**HEAD**

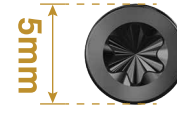

Jolt Head - A small head (5mm) for applications where the head is required to be concealed

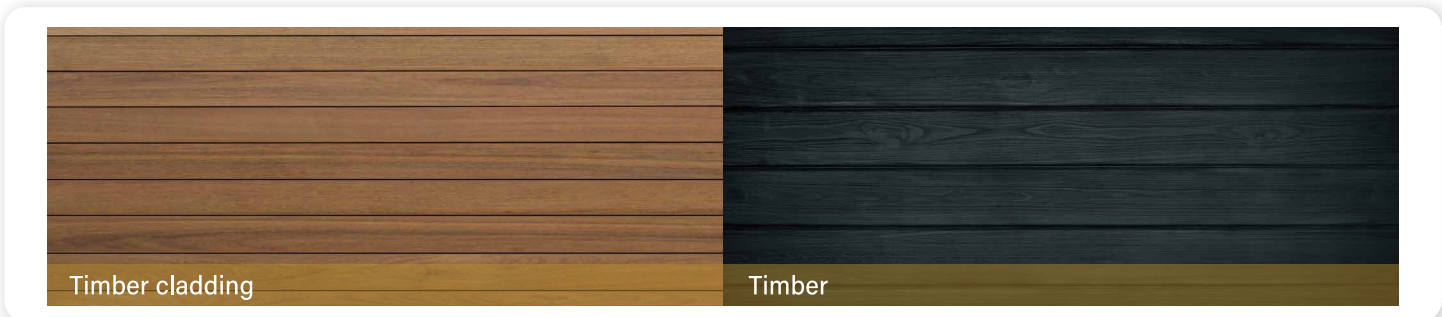

\*Please refer to the technical specification for fastener requirements or installation manual for each specific application you are working with.

316 Stainless Steel Black - Outdoor & Sea Spray Zone Use					
Diameter	Length (mm)	Product Code	Drive	PCS / Pack	Pack / Outer
8G	75	WDJBK8G75-100	T15 Drive	100	6
	75	WDJBK8G75-400	T15 Drive	400	5

# T-REX17® SteelZipz™ Screw

Jolt Head, TX Drive - 316 Stainless Steel Bi-Metal

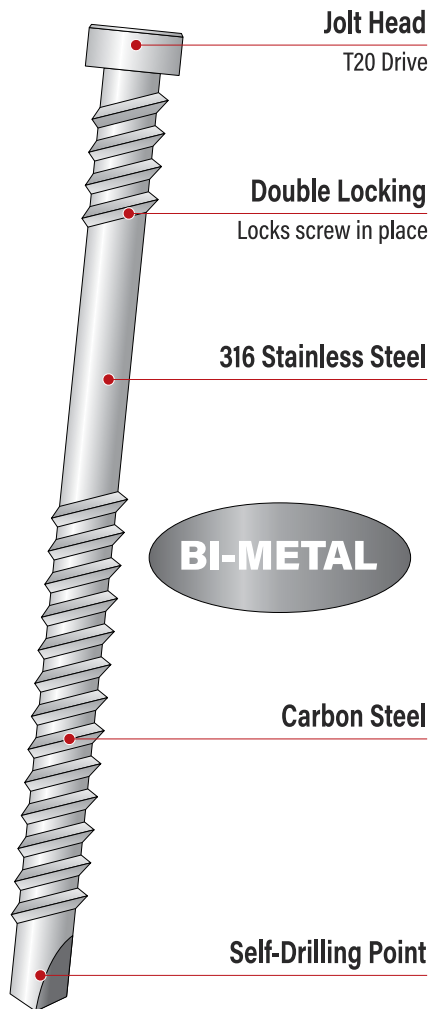

## DRIVE



T20 Drive

## DRIVER BIT



Included in each packet

## FINISH



Outdoor / Sea  
Spray Zone Use

## PACKAGING

Recyclable



5mm

## HEAD

Jolt Head - A small head (5mm) for applications where the head is required to be concealed



Steel framing system

\*Please refer to the technical specification for fastener requirements or installation manual for each specific application you are working with.

316 Stainless Steel - Outdoor & Sea Spray Zone Use					
Diameter	Length (mm)	Product Code	Drive	PCS / Pack	Pack / Outer
10G	65	WDJB110G65-250	T20 Drive	250	5

# SCREW SERIES



● **BATTEN SCREWS**



● **PURLIN SCREWS**



● **TIMBER SCREWS**



● **COUNTERSUNK** ● **OVAL** ● **TRIM HEAD** ● **CYLINDRICAL** ● **JoltScrew**



● **CONSTRUCTION SCREWS**

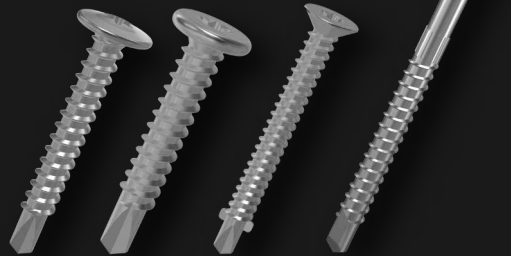

● **METAL SCREWS**



● **WOOD SCREWS**

# T-REX17® Decking Screws - Countersunk

Countersunk Head, TX Drive - 304 Stainless Steel

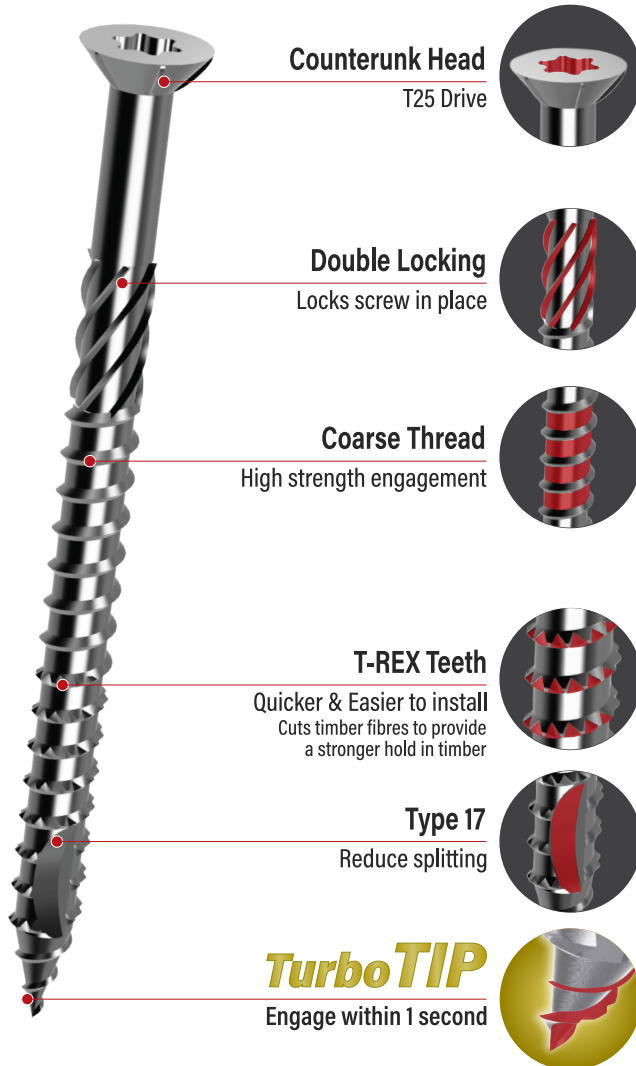

**Counterunk Head**  
T25 Drive



**Double Locking**  
Locks screw in place



**Coarse Thread**  
High strength engagement

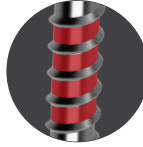

**T-REX Teeth**  
Quicker & Easier to install  
Cuts timber fibres to provide a stronger hold in timber

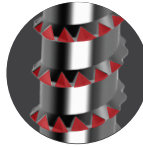

**Type 17**  
Reduce splitting

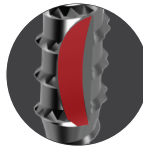

**TurboTIP**  
Engage within 1 second



**DRIVE**



T25 Drive

**DRIVER BIT**



Included in each packet



**FINISH**

Outdoor / Sea Spray Zone Use

**90mm**

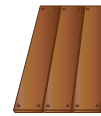

Approx.  
**0.85m<sup>2</sup>**  
50 screws

Approx.  
**4.25m<sup>2</sup>**  
250 screws

**140mm**

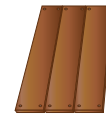

Approx.  
**1.25m<sup>2</sup>**  
50 screws

Approx.  
**6.25m<sup>2</sup>**  
250 screws

Approx.  
**8.5m<sup>2</sup>**  
500 screws

Approx.  
**17m<sup>2</sup>**  
1000 screws

Approx.  
**12.5m<sup>2</sup>**  
500 screws

Approx.  
**25m<sup>2</sup>**  
1000 screws

**ECKO-FRIENDLY PACKAGING**  
Recyclable

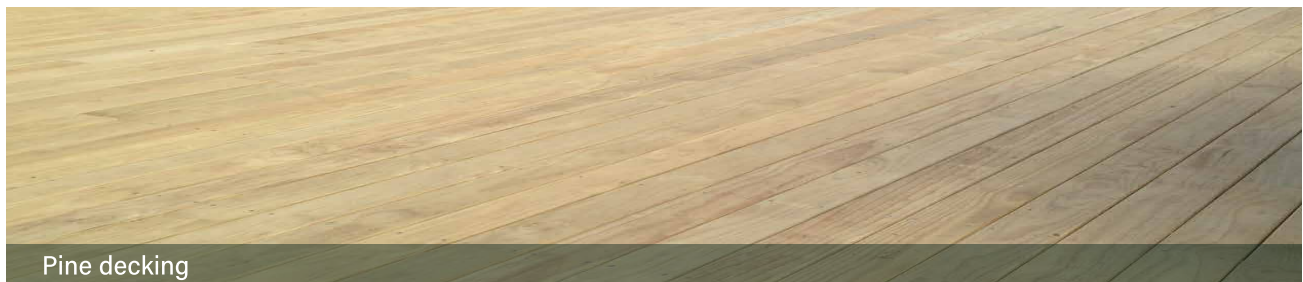

Pine decking

\*Please refer to the technical specification for fastener requirements or installation manual for each specific application you are working with.

304 Stainless Steel - Outdoor & Sea Spray Zone Use					
Diameter	Length (mm)	Product Code	Drive	PCS / Pack	Pack / Outer
10G	60	DCS30410G60-50	T25 Drive	50	6
	60	DCS30410G60-250	T25 Drive	250	5
	60	DCS30410G60-500	T25 Drive	500	4
	60	DCS30410G60-1K	T25 Drive	1000	1
	65	DCS30410G65-50	T25 Drive	50	6
	65	DCS30410G65-250	T25 Drive	250	5
	65	DCS30410G65-500	T25 Drive	500	4
	65	DCS30410G65-1K	T25 Drive	1000	1
	75	DCS30410G75-50	T25 Drive	50	6
	75	DCS30410G75-250	T25 Drive	250	5
	75	DCS30410G75-500	T25 Drive	500	4
	75	DCS30410G75-1K	T25 Drive	1000	1

# T-REX17® Decking Screws - Countersunk

Countersunk Head, TX Drive - 304 Stainless Steel Bronze

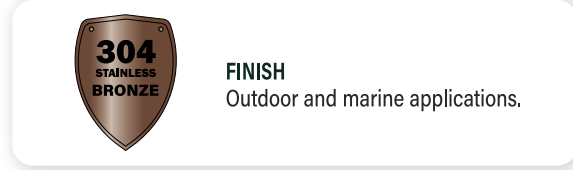
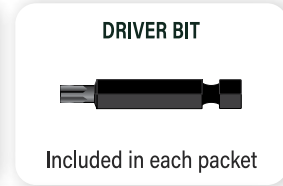
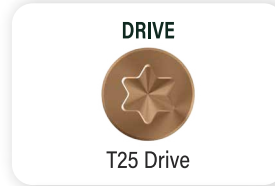
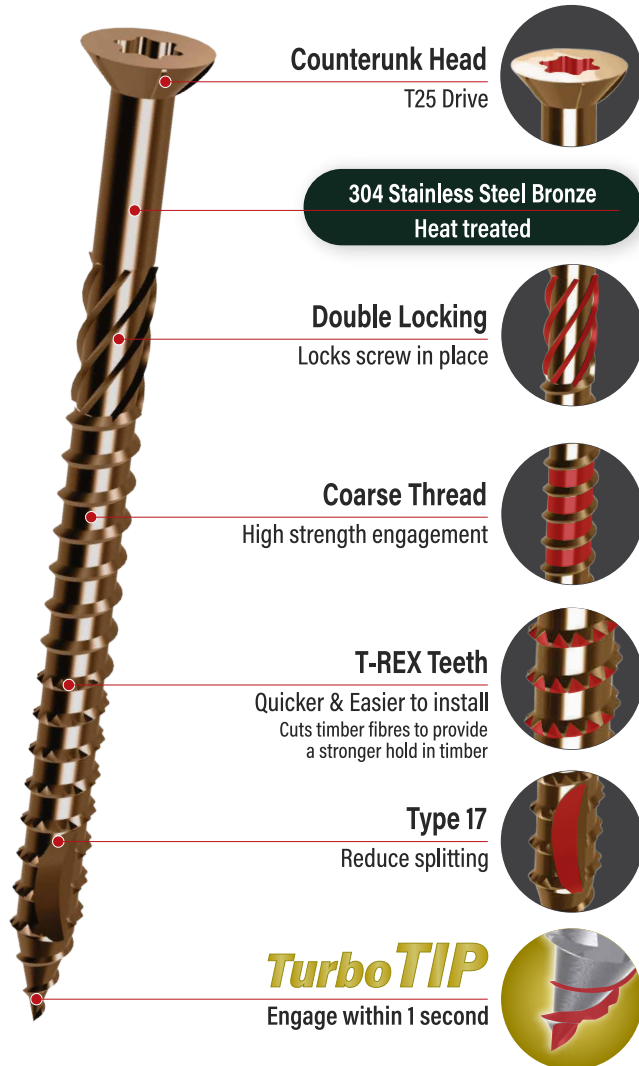

90mm		140mm	
Approx. <b>0.85m<sup>2</sup></b> 50 screws	Approx. <b>4.25m<sup>2</sup></b> 250 screws	Approx. <b>1.25m<sup>2</sup></b> 50 screws	Approx. <b>6.25m<sup>2</sup></b> 250 screws
Approx. <b>8.5m<sup>2</sup></b> 500 screws	Approx. <b>17m<sup>2</sup></b> 1000 screws	Approx. <b>12.5m<sup>2</sup></b> 500 screws	Approx. <b>25m<sup>2</sup></b> 1000 screws

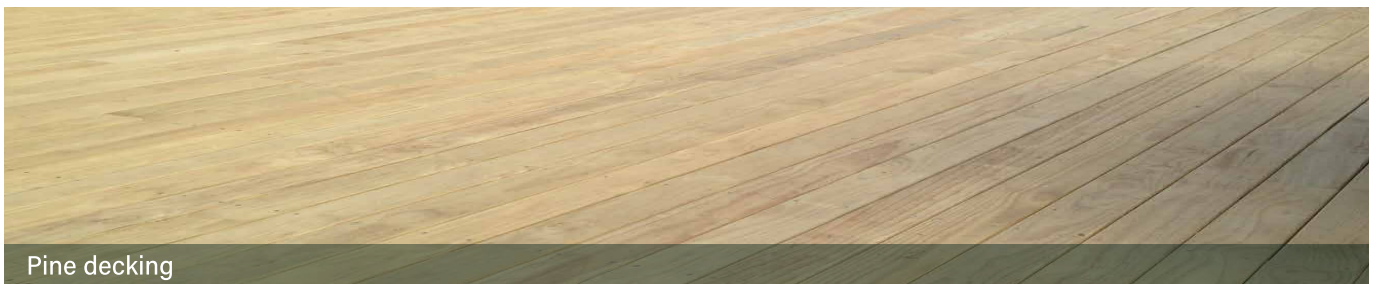

\*Please refer to the technical specification for fastener requirements or installation manual for each specific application you are working with.

304 Stainless Steel Bronze - Outdoor & Sea Spray Zone Use					
Diameter	Length (mm)	Product Code	Drive	PCS / Pack	Pack / Outer
10G	65	DCS304BZ10G65-250	T25 Drive	250	5
		DCS304BZ10G65-1K	T25 Drive	1000	1

# T-REX17® Decking Screws - Oval Head

Oval Head, TX Drive - 304 Stainless Steel

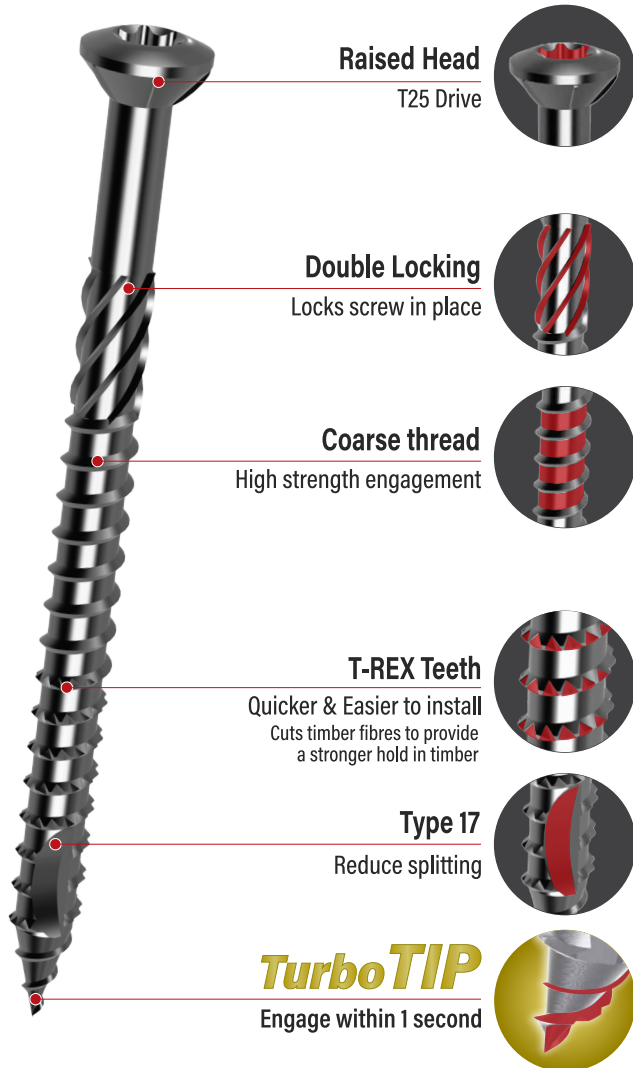

**Raised Head**  
T25 Drive



**Double Locking**  
Locks screw in place



**Coarse thread**  
High strength engagement

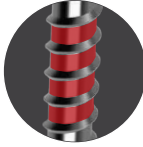

**T-REX Teeth**  
Quicker & Easier to install  
Cuts timber fibres to provide a stronger hold in timber

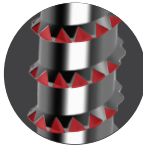

**Type 17**  
Reduce splitting

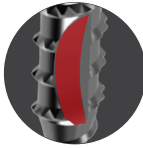

**Turbo TIP**  
Engage within 1 second



**DRIVE**



T25 Drive

**DRIVER BIT**



Included in each packet



**FINISH**

Outdoor / Sea Spray Zone Use

**90mm**

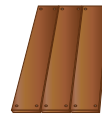

Approx.  
**0.85m<sup>2</sup>**  
50 screws

Approx.  
**4.25m<sup>2</sup>**  
250 screws

**140mm**

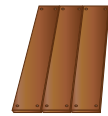

Approx.  
**1.25m<sup>2</sup>**  
50 screws

Approx.  
**6.25m<sup>2</sup>**  
250 screws

Approx.  
**8.5m<sup>2</sup>**  
500 screws

Approx.  
**17m<sup>2</sup>**  
1000 screws

Approx.  
**12.5m<sup>2</sup>**  
500 screws

Approx.  
**25m<sup>2</sup>**  
1000 screws

**ECKO-FRIENDLY PACKAGING**  
Recyclable



Pine decking

\*Please refer to the technical specification for fastener requirements or installation manual for each specific application you are working with.

304 Stainless Steel - Outdoor & Sea Spray Zone Use					
Diameter	Length (mm)	Product Code	Drive	PCS / Pack	Pack / Outer
10G	60	DOV30410G60-50	T25 Drive	50	6
	60	DOV30410G60-250	T25 Drive	250	5
	60	DOV30410G60-500	T25 Drive	500	4
	60	DOV30410G60-1K	T25 Drive	1000	1
	65	DOV30410G65-50	T25 Drive	50	6
	65	DOV30410G65-250	T25 Drive	250	5
	65	DOV30410G65-500	T25 Drive	500	4
	65	DOV30410G65-1K	T25 Drive	1000	1
	75	DOV30410G75-50	T25 Drive	50	6
	75	DOV30410G75-250	T25 Drive	250	5
	75	DOV30410G75-500	T25 Drive	500	4
	75	DOV30410G75-1K	T25 Drive	1000	1

# T-REX17® 10G & 12G Decking Screws - Trim Head

Trim Head, TX Drive - 316 Stainless Steel

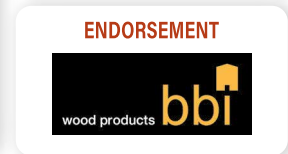
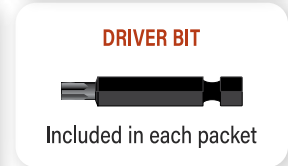
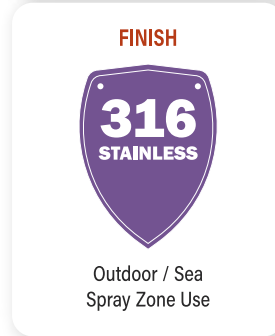
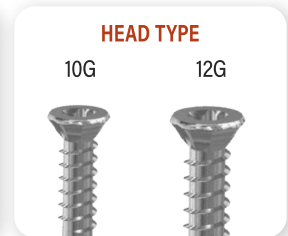
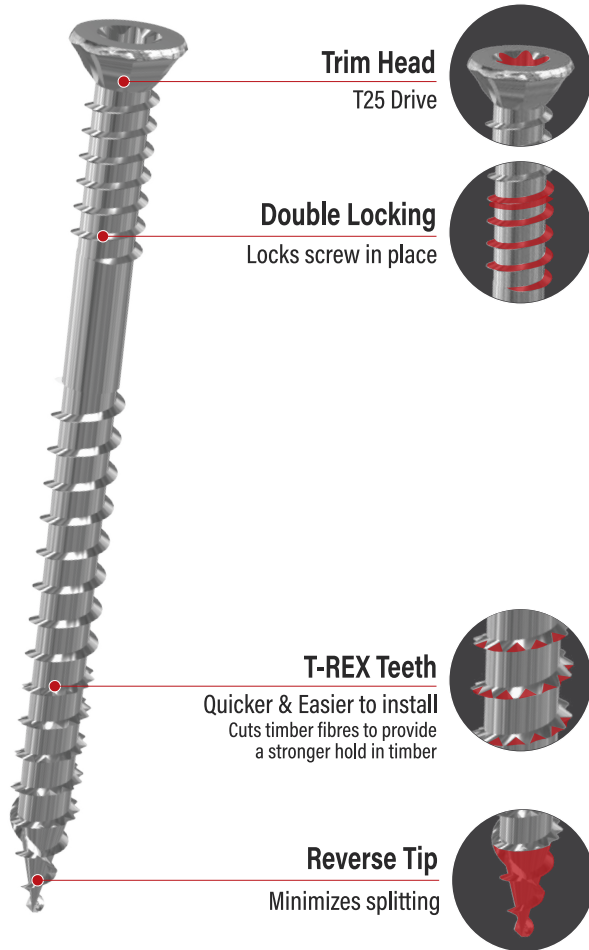

90mm		140mm	
Approx. <b>0.85m<sup>2</sup></b> 50 screws	Approx. <b>4.25m<sup>2</sup></b> 250 screws	Approx. <b>1.25m<sup>2</sup></b> 50 screws	Approx. <b>6.25m<sup>2</sup></b> 250 screws
Approx. <b>8.5m<sup>2</sup></b> 500 screws	Approx. <b>17m<sup>2</sup></b> 1000 screws	Approx. <b>12.5m<sup>2</sup></b> 500 screws	Approx. <b>25m<sup>2</sup></b> 1000 screws

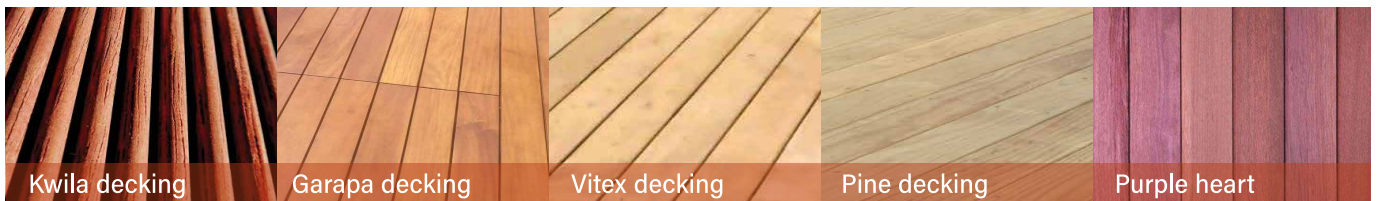

\*Please refer to the technical specification for fastener requirements or installation manual for each specific application you are working with.

316 Stainless Steel - Outdoor & Sea Spray Zone Use					
Diameter	Length (mm)	Product Code	Drive	PCS / Pack	Pack / Outer
10G	60	DTR31610G60-50	T25 Drive	50	6
	60	DTR31610G60-250	T25 Drive	250	5
	60	DTR31610G60-500	T25 Drive	500	4
	60	DTR31610G60-1K	T25 Drive	1000	1
	65	DTR31610G65-50	T25 Drive	50	6
	65	DTR31610G65-250	T25 Drive	250	5
	65	DTR31610G65-500	T25 Drive	500	4
	65	DTR31610G65-1K	T25 Drive	1000	1
	75	DTR31610G75-50	T25 Drive	50	6
	75	DTR31610G75-250	T25 Drive	250	5
	75	DTR31610G75-500	T25 Drive	500	4
	75	DTR31610G75-1K	T25 Drive	1000	1
12G	65	DTR31612G65-50	T25 Drive	50	6
	65	DTR31612G65-250	T25 Drive	250	5
	75	DTR31612G75-50	T25 Drive	50	6
	75	DTR31612G75-250	T25 Drive	250	5
	90	DTR31612G90-50	T25 Drive	50	6
	90	DTR31612G90-250	T25 Drive	250	5

# T-REX17® Decking Screws - Trim Head

Trim Head, TX Drive - 316 Stainless Steel Bronze

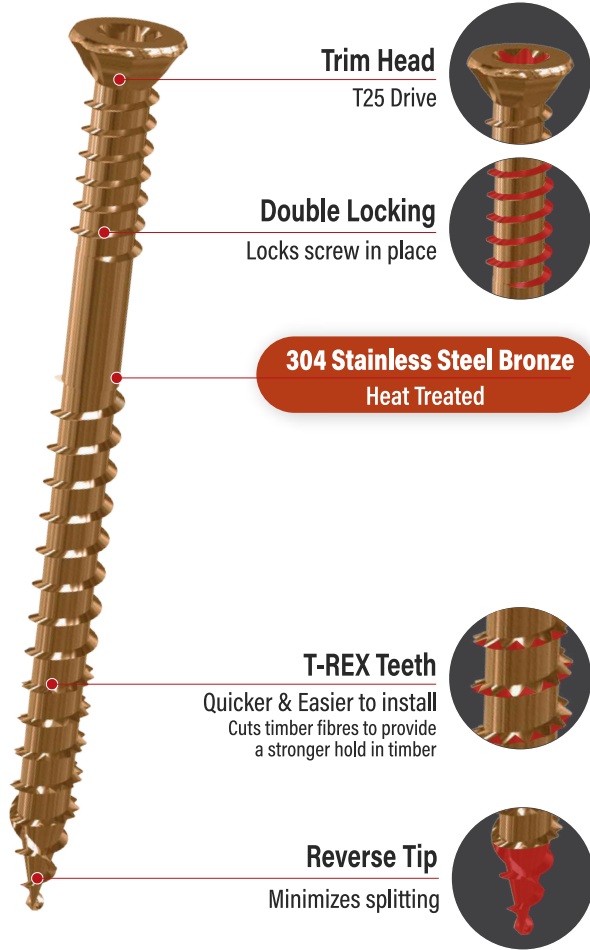

**DRIVE**



T25 Drive

**DRIVER BIT**



Included in each packet

**FINISH**



Outdoor / Marine Applications Use

**ENDORSEMENT**



**90mm**

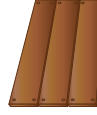

Approx. **0.85m<sup>2</sup>**  
50 screws

Approx. **4.25m<sup>2</sup>**  
250 screws

Approx. **8.5m<sup>2</sup>**  
500 screws

Approx. **17m<sup>2</sup>**  
1000 screws

**140mm**



Approx. **1.25m<sup>2</sup>**  
50 screws

Approx. **6.25m<sup>2</sup>**  
250 screws

Approx. **12.5m<sup>2</sup>**  
500 screws

Approx. **25m<sup>2</sup>**  
1000 screws

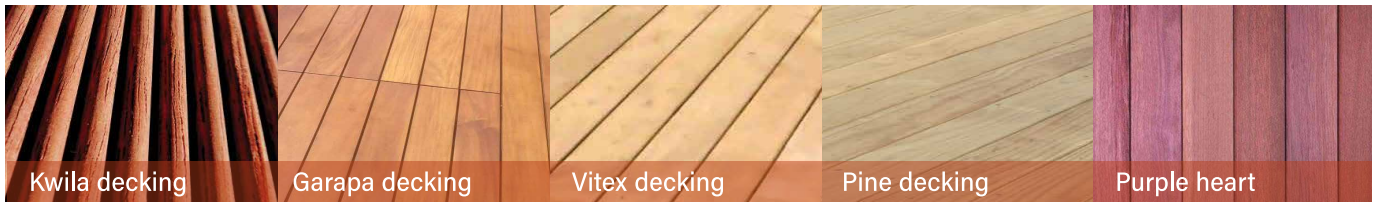

\*Please refer to the technical specification for fastener requirements or installation manual for each specific application you are working with.

316 Stainless Steel Bronze - Outdoor & Sea Spray Zone Use					
Diameter	Length (mm)	Product Code	Drive	PCS / Pack	Pack / Outer
10G	65	DTRBZ10G65-250	T25 Drive	250	5

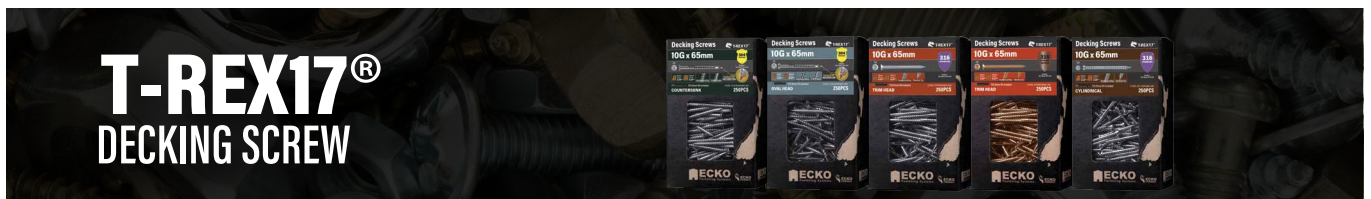

**T-REX17®**  
**DECKING SCREW**

# T-REX17® Decking Screws - Cylindrical Head

Cylindrical Head, TX Drive - 316 Stainless Steel

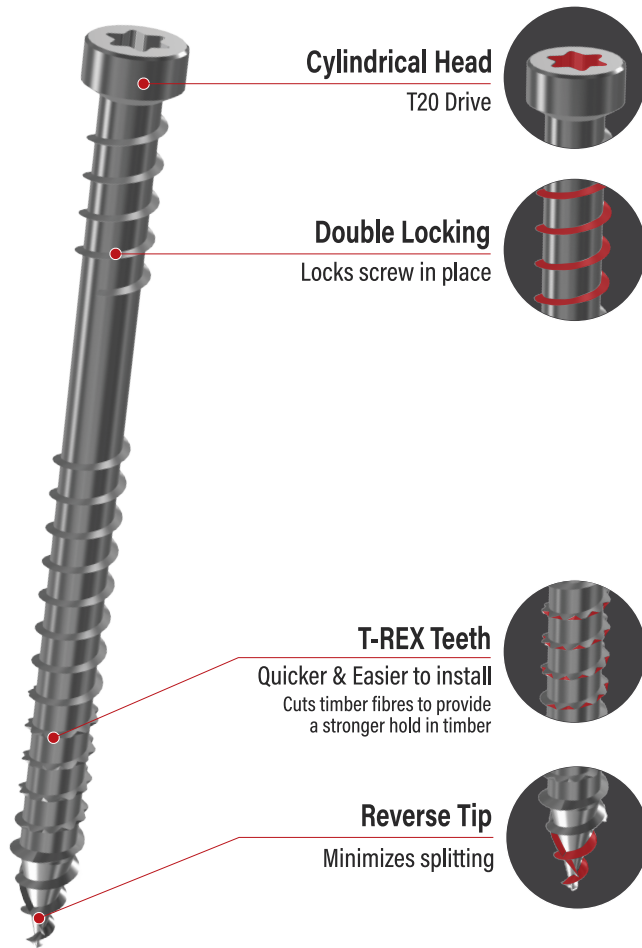

**Cylindrical Head**  
T20 Drive

**Double Locking**  
Locks screw in place

**T-REX Teeth**  
Quicker & Easier to install  
Cuts timber fibres to provide a stronger hold in timber

**Reverse Tip**  
Minimizes splitting

## DRIVE



T20 Drive

## DRIVER BIT



Included in each packet

## FINISH



For outdoor / sea spray zone use.

## ENDORSEMENT



## 90mm

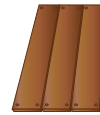

Approx. **0.85m<sup>2</sup>**  
50 screws

Approx. **4.25m<sup>2</sup>**  
250 screws

## 140mm

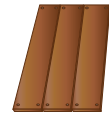

Approx. **1.25m<sup>2</sup>**  
50 screws

Approx. **6.25m<sup>2</sup>**  
250 screws

Approx. **8.5m<sup>2</sup>**  
500 screws

Approx. **17m<sup>2</sup>**  
1000 screws

Approx. **12.5m<sup>2</sup>**  
500 screws

Approx. **25m<sup>2</sup>**  
1000 screws

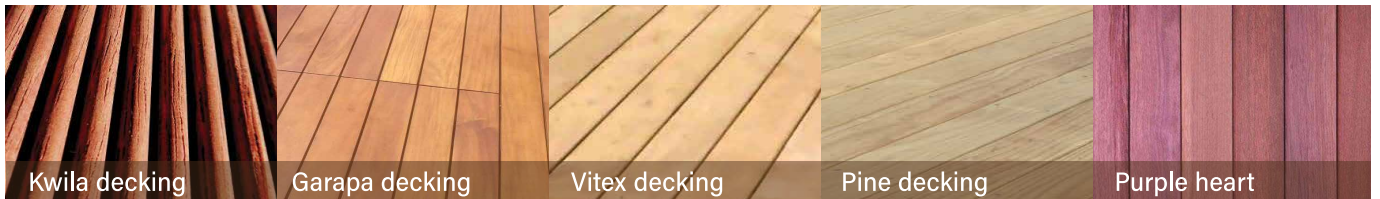

\*Please refer to the technical specification for fastener requirements or installation manual for each specific application you are working with.

316 Stainless Steel - Outdoor & Sea Spray Zone Use					
Diameter	Length (mm)	Product Code	Drive	PCS / Pack	Pack / Outer
10G	60	DCL31610G60-50	T20 Drive	50	6
	60	DCL31610G60-250	T20 Drive	250	5
	60	DCL31610G60-500	T20 Drive	500	4
	60	DCL31610G60-1K	T20 Drive	1000	1
	65	DCL31610G65-50	T20 Drive	50	6
	65	DCL31610G65-250	T20 Drive	250	5
	65	DCL31610G65-500	T20 Drive	500	4
	65	DCL31610G65-1K	T20 Drive	1000	1
	75	DCL31610G75-50	T20 Drive	50	6
	75	DCL31610G75-250	T20 Drive	250	5
	75	DCL31610G75-500	T20 Drive	500	4
	75	DCL31610G75-1K	T20 Drive	1000	1

# T-REX17® TimbaTX® 8G & 10G Timber Screws

Countersunk Head, TX Drive - Yellow Zinc

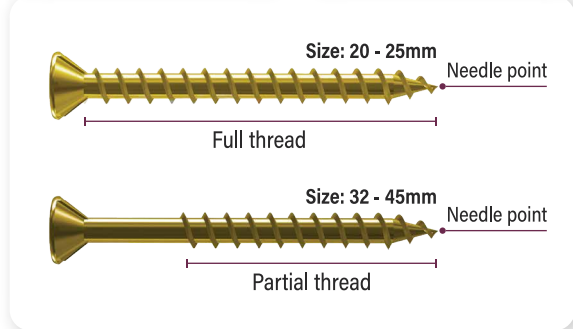
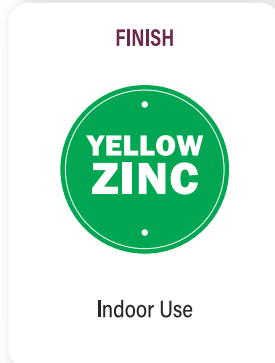
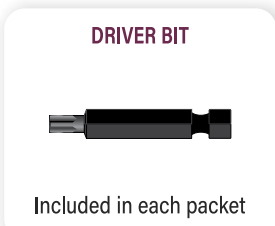
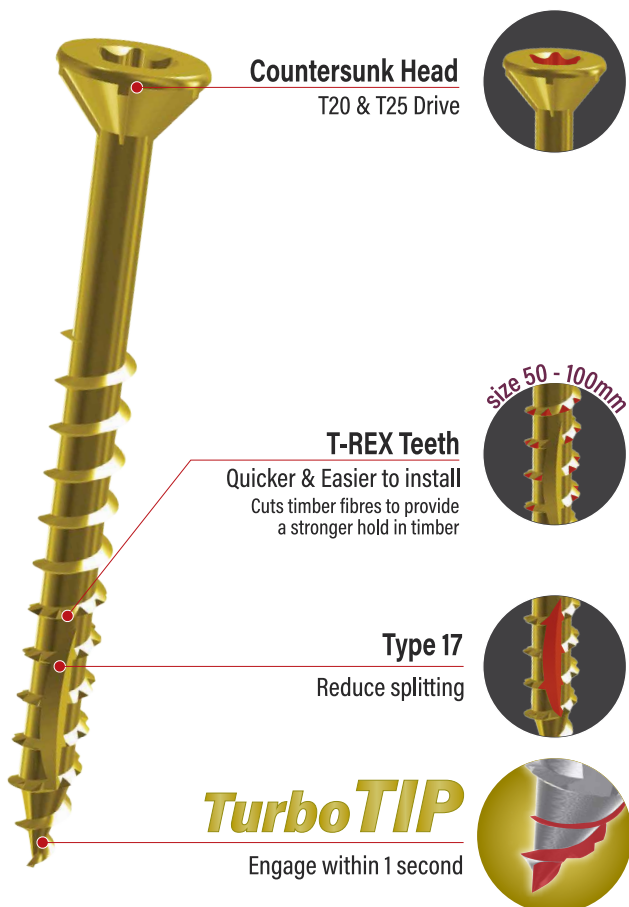

\*Please refer to the technical specification for fastener requirements or installation manual for each specific application you are working with.

Yellow Zinc - Indoor Use					
Diameter	Length (mm)	Product Code	Drive	PCS / Pack	Pack / Outer
8G	20	TTYZ8G20-200	T20 Drive	200	6
	20	TTYZ8G20-1K	T20 Drive	1000	5
	25	TTYZ8G25-200	T20 Drive	200	6
	25	TTYZ8G25-1K	T20 Drive	1000	5
	32	TTYZ8G32-200	T20 Drive	200	6
	32	TTYZ8G32-1K	T20 Drive	1000	5
	40	TTYZ8G40-150	T20 Drive	150	6
	40	TTYZ8G40-500	T20 Drive	500	5
	45	TTYZ8G45-150	T20 Drive	150	6
	45	TTYZ8G45-500	T20 Drive	500	5
	50	TTYZ8G50-125	T20 Drive	125	6
	50	TTYZ8G50-500	T20 Drive	500	5
	65	TTYZ8G65-125	T20 Drive	125	6
	65	TTYZ8G65-500	T20 Drive	500	5
10G	50	TTYZ10G50-100	T25 Drive	100	6
	50	TTYZ10G50-300	T25 Drive	300	5
	65	TTYZ10G65-100	T25 Drive	100	6
	65	TTYZ10G65-300	T25 Drive	300	5
	75	TTYZ10G75-75	T25 Drive	75	6
	75	TTYZ10G75-300	T25 Drive	300	5
	90	TTYZ10G90-75	T25 Drive	75	6
	90	TTYZ10G90-300	T25 Drive	300	5
	100	TTYZ10G100-75	T25 Drive	75	6
	100	TTYZ10G100-300	T25 Drive	300	5

# T-REX17® TimbaTX® 8G & 10G Timber Screws

Countersunk Head, TX Drive - Outdoor XGuard

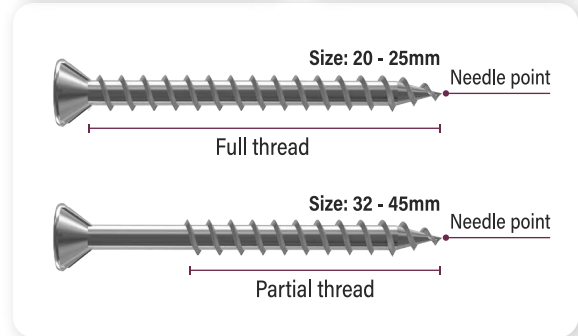
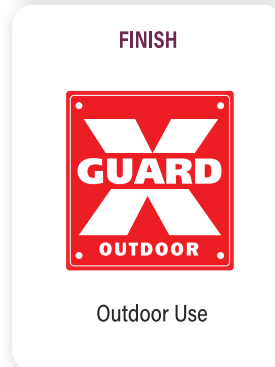
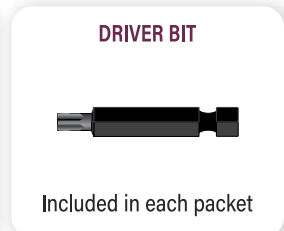
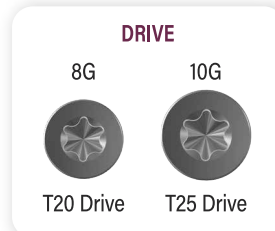
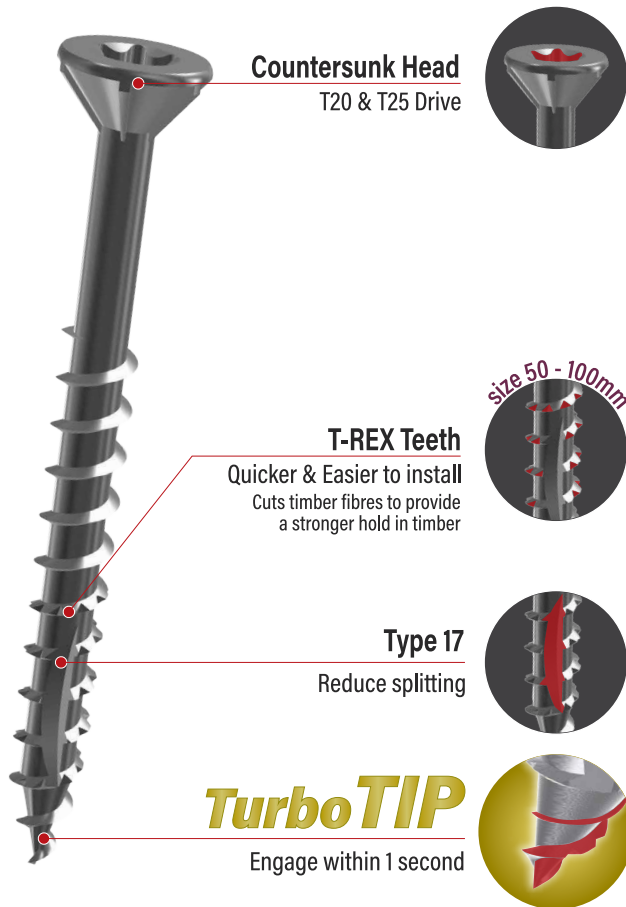

\*Please refer to the technical specification for fastener requirements or installation manual for each specific application you are working with.

Outdoor XGuard - Outdoor Use					
Diameter	Length (mm)	Product Code	Drive	PCS / Pack	Pack / Outer
8G	20	TTXG8G20-200	T20 Drive	200	6
	20	TTXG8G20-1K	T20 Drive	1000	5
	25	TTXG8G25-200	T20 Drive	200	6
	25	TTXG8G25-1K	T20 Drive	1000	5
	32	TTXG8G32-200	T20 Drive	200	6
	32	TTXG8G32-1K	T20 Drive	1000	5
	40	TTXG8G40-150	T20 Drive	150	6
	40	TTXG8G40-500	T20 Drive	500	5
	45	TTXG8G45-150	T20 Drive	150	6
	45	TTXG8G45-500	T20 Drive	500	5
	50	TTXG8G50-125	T20 Drive	125	6
	50	TTXG8G50-500	T20 Drive	500	5
	65	TTXG8G65-125	T20 Drive	125	6
	65	TTXG8G65-500	T20 Drive	500	5
10G	50	TTXG10G50-100	T25 Drive	100	6
	50	TTXG10G50-300	T25 Drive	300	5
	65	TTXG10G65-100	T25 Drive	100	6
	65	TTXG10G65-300	T25 Drive	300	5
	75	TTXG10G75-75	T25 Drive	75	6
	75	TTXG10G75-300	T25 Drive	300	5
	90	TTXG10G90-75	T25 Drive	75	6
	90	TTXG10G90-300	T25 Drive	300	5
	100	TTXG10G100-75	T25 Drive	75	6
	100	TTXG10G100-300	T25 Drive	300	5

# T-REX17® TimbaTX® 8G & 10G Timber Screws

Countersunk Head, TX Drive - 304 Stainless Steel

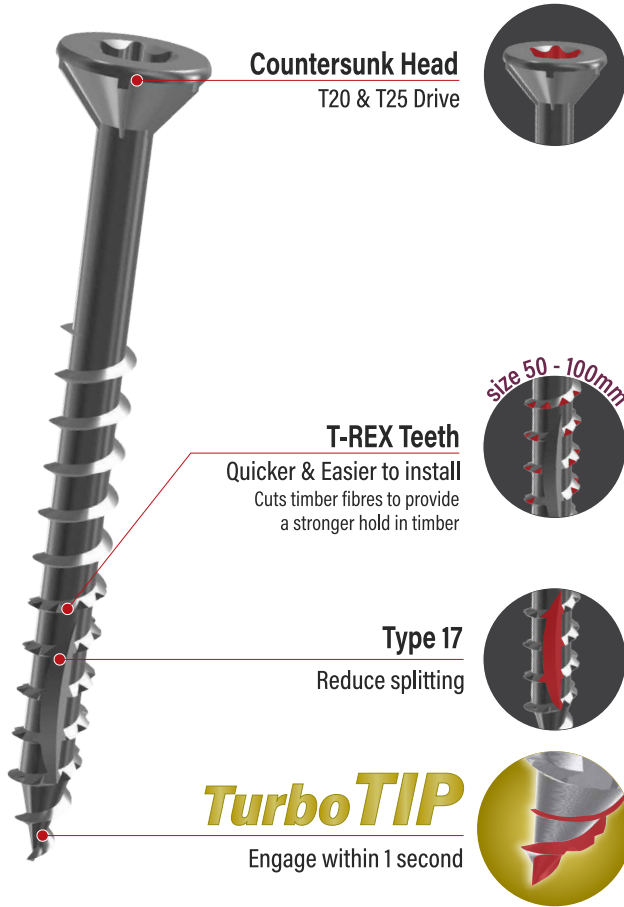

**DRIVE**

8G      10G

T20 Drive      T25 Drive

**DRIVER BIT**

Included in each packet

**FINISH**

Outdoor / Sea Spray Zone Use

**ECKO-FRIENDLY PACKAGING**  
Recyclable

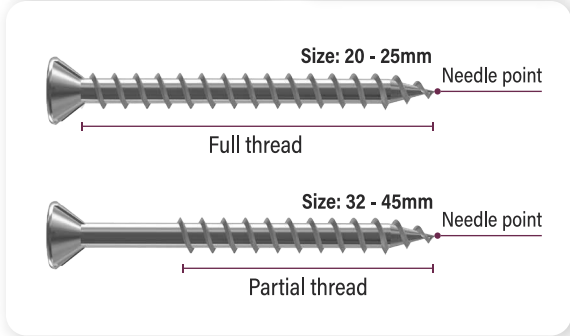

\*Please refer to the technical specification for fastener requirements or installation manual for each specific application you are working with.

304 Stainless Steel - Outdoor & Sea Spray Zone Use					
Diameter	Length (mm)	Product Code	Drive	PCS / Pack	Pack / Outer
8G	20	TT3048G20-200	T20 Drive	200	6
	20	TT3048G20-1K	T20 Drive	1000	5
	25	TT3048G25-200	T20 Drive	200	6
	25	TT3048G25-1K	T20 Drive	1000	5
	32	TT3048G32-200	T20 Drive	200	6
	32	TT3048G32-1K	T20 Drive	1000	5
	40	TT3048G40-150	T20 Drive	150	6
	40	TT3048G40-500	T20 Drive	500	5
	45	TT3048G45-150	T20 Drive	150	6
	45	TT3048G45-500	T20 Drive	500	5
	50	TT3048G50-125	T20 Drive	125	6
	50	TT3048G50-500	T20 Drive	500	5
	65	TT3048G65-125	T20 Drive	125	6
	65	TT3048G65-500	T20 Drive	500	5
10G	50	TT30410G50-100	T25 Drive	100	6
	50	TT30410G50-300	T25 Drive	300	5
	65	TT30410G65-100	T25 Drive	100	6
	65	TT30410G65-300	T25 Drive	300	5
	75	TT30410G75-75	T25 Drive	75	6
	75	TT30410G75-300	T25 Drive	300	5
	90	TT30410G90-75	T25 Drive	75	6
	90	TT30410G90-300	T25 Drive	300	5
	100	TT30410G100-75	T25 Drive	75	6
	100	TT30410G100-300	T25 Drive	300	5

# T-REX17® Purlin Screws

Countersunk Head, TX Drive - Blue Ruspert

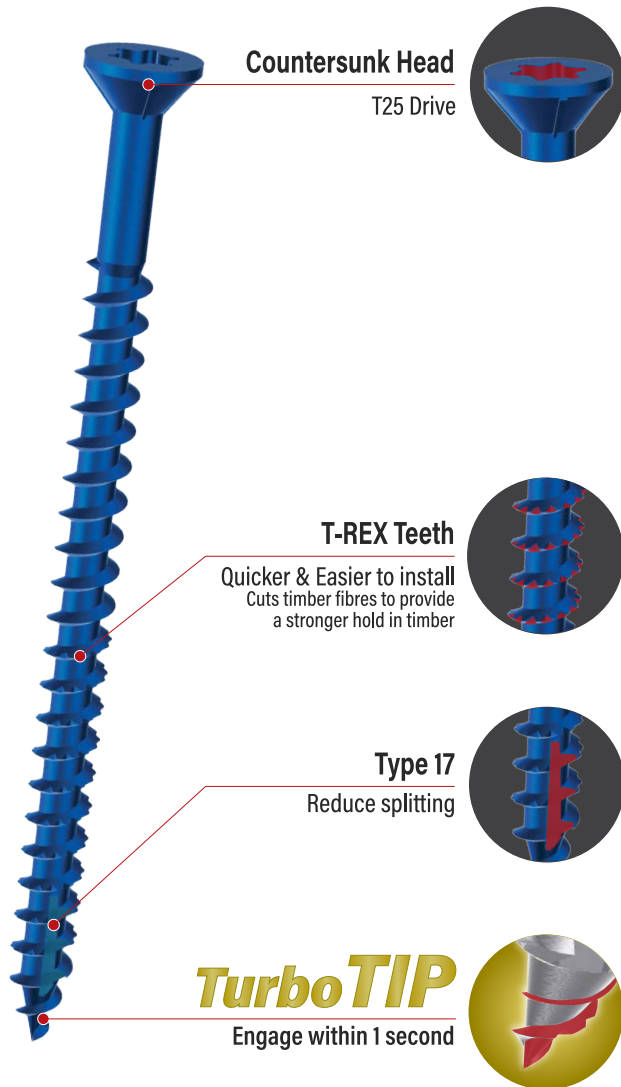

**DRIVE**



T25 TX Drive

**DRIVER BIT**



Included in each packet

**FINISH**



Indoor & Outdoor use, particularly effective for purlin and batten fixing.

**ECKO-FRIENDLY PACKAGING**  
Recyclable



**PURLIN / BATTEN**

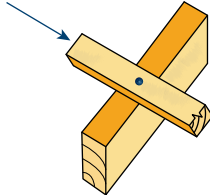

1 / ECKO T-REX17® Purlin Screw, 10g x 80mm  
**4.79kN**  
Characteristic Strength

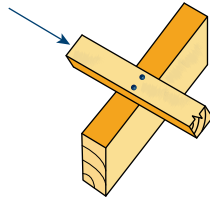

2 / ECKO T-REX17® Purlin Screw, 10g x 80mm (for purlin on edge)  
**9.19kN**  
Characteristic Strength

## FIXING GUIDE (Maximum spacing and fixing)

This is a guide ONLY, reference Table 10.10, section 10 of NZS 3604:2011

Purlin Size	Max. SPAN	Low		Medium		High		Very High		Extra High	
		Spacing	Fixing	Spacing	Fixing	Spacing	Fixing	Spacing	Fixing	Spacing	Fixing
70 x 45	900mm	900mm	S	900mm	T	900mm	T	900mm	T	900mm	U
70 x 45	900mm	1200mm	T	1200mm	T	1200mm	T	1050mm	U	900mm	U
70 x 45	900mm	1800mm	T	1800mm	U	1400mm	U	1050mm	U	900mm	U
70 x 45	1200mm	1200mm	T	1150mm	T	800mm	T	600mm	T	500mm	T
70 x 45	1200mm	1300mm	T	1150mm	T	800mm	T	600mm	T	500mm	T
90 x 45	1200mm	1700mm	T	1450mm	U	1000mm	U	750mm	U	650mm	U
Fixing Type		Description								Alternative Fixing Capacity (kN)	
S		2 x 90x3.15mm framing nails								0.8	
T		1 x 10gx80mm ECKO T-REX17® Purlin Screws								2.4	
U		2 x 10gx80mm ECKO T-REX17® Purlin Screws or 1 x 14gx100mm ECKO T-REX17® Batten Screw								5.5	

**NOTE:** All fixing types are determined as required for the higher uplift loads at the periphery of the roof (based on local pressure factors in AS/NZS1170.2)

\*Please refer to the technical specification for fastener requirements or installation manual for each specific application you are working with.

Blue Ruspert					
Diameter	Length (mm)	Product Code	Drive	PCS / Pack	Pack / Outer
10G	80	DCSPU10G80-250	T25 Drive	250	5

# T-REX17® Construction Screws

Wafer Head, TX Drive - OutDoor XGuard & 304 Stainless Steel

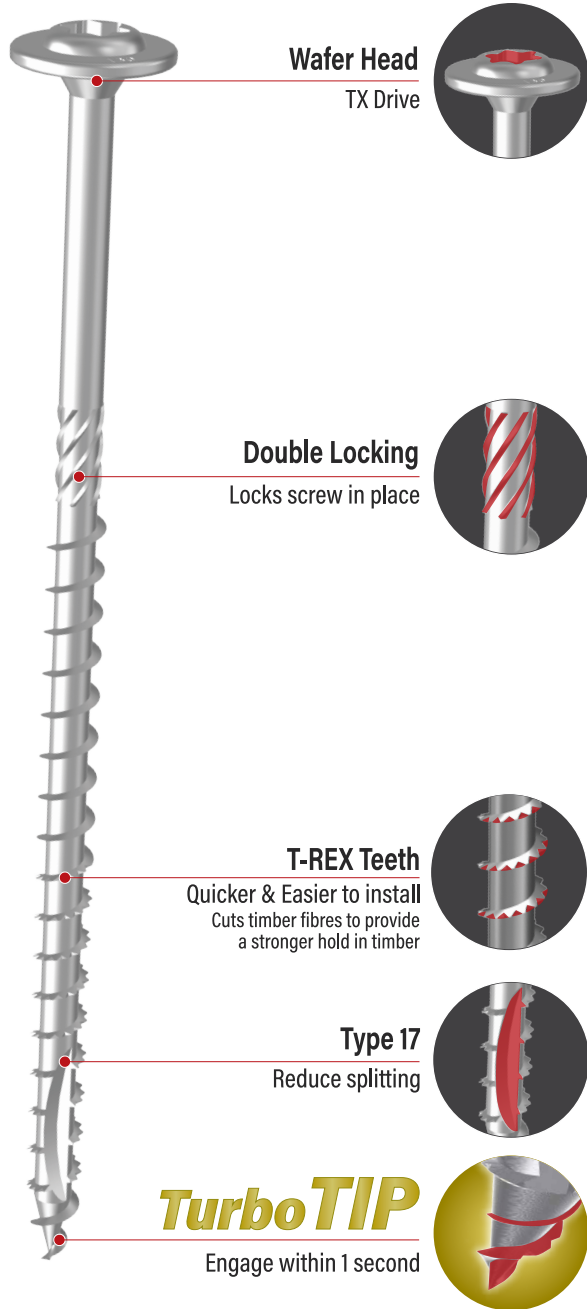

**TECHNICAL DATA AVAILABLE**

**DRIVER BIT**



Excluded

**DRIVE**

M6



T30 Drive

M8



T40 Drive

M10



T50 Drive

**FINISH**



Outdoor Use



Outdoor / Sea  
Spray Zone Use

**ECKO-FRIENDLY PACKAGING**

Recyclable



Timber construction

\*Please refer to the technical specification for fastener requirements or installation manual for each specific application you are working with.

# T-REX17® Construction Screws

Wafer Head, TX Drive - OutDoor XGuard & 304 Stainless Steel

OutDoor XGuard - Outdoor Use					
Diameter	Length (mm)	Product Code	Drive	PCS / Pack	Pack / Outer
M6	80	TCWM680L-100	T30 Drive	100	18
	100	TCWM6100L-100	T30 Drive	100	18
	120	TCWM6120L-100	T30 Drive	100	12
	140	TCWM6140L-100	T30 Drive	100	8
	160	TCWM6160L-100	T30 Drive	100	8
	180	TCWM6180L-100	T30 Drive	100	8
M8	80	TCWM880L-50	T40 Drive	50	12
	100	TCWM8100L-50	T40 Drive	50	12
	120	TCWM8120L-50	T40 Drive	50	12
	140	TCWM8140L-50	T40 Drive	50	12
	160	TCWM8160L-50	T40 Drive	50	8
	180	TCWM8180L-50	T40 Drive	50	8
	200	TCWM8200L-50	T40 Drive	50	8
	360	TCWM10360L-25	T50 Drive	25	6
M10	80	TCWM1080L-50	T50 Drive	50	6
	100	TCWM10100L-50	T50 Drive	50	6
	120	TCWM10120L-50	T50 Drive	50	6
	140	TCWM10140L-25	T50 Drive	25	12
	160	TCWM10160L-25	T50 Drive	25	12
	180	TCWM10180L-25	T50 Drive	25	12
	200	TCWM10200L-25	T50 Drive	25	12
	220	TCWM10220L-25	T50 Drive	25	12
	240	TCWM10240L-25	T50 Drive	25	6
	260	TCWM10260L-25	T50 Drive	25	6
	280	TCWM10280L-25	T50 Drive	25	6
	300	TCWM10300L-25	T50 Drive	25	6
304 Stainless Steel - Outdoor & Sea Spray Zone Use					
Diameter	Length (mm)	Product Code	Drive	PCS / Pack	Pack / Outer
M8	80	TCWSSM880L-50	T40 Drive	50	12
	100	TCWSSM8100L-50	T40 Drive	50	12
	120	TCWSSM8120L-50	T40 Drive	50	12
	140	TCWSSM8140L-50	T40 Drive	50	12
	160	TCWSSM8160L-50	T40 Drive	50	8
	180	TCWSSM8180L-50	T40 Drive	50	8
	200	TCWSSM8200L-50	T40 Drive	50	8

## SCREW DURABILITY TABLE

ECKO Construction Screws OutDoor XGuard

Building Location	Cladding that acts as bracing (50 year durability)	Non-Structural Cladding (15 year durability)	Framing in "Closed" areas (including roof spaces)
Zone B & C	304 Stainless Steel	OutDoor XGuard	Mild Steel
Zone D	304 Stainless Steel	OutDoor XGuard	Mild Steel
Building Location	Framing in "Sheltered" areas		Framing in "Exposed" areas
Zone B & C	OutDoor XGuard		304 Stainless Steel
Zone D	OutDoor XGuard		304 Stainless Steel

ECKO T-REX17® Construction Screws are manufactured with OutDoor XGuard coating for use in sheltered conditions as per **NZS3604 Corrosion Zone Table 4.3 Nail and Screw use**.

# T-REX17® Construction Screws

Countersunk Head, TX Drive - OutDoor XGuard & 304 Stainless Steel

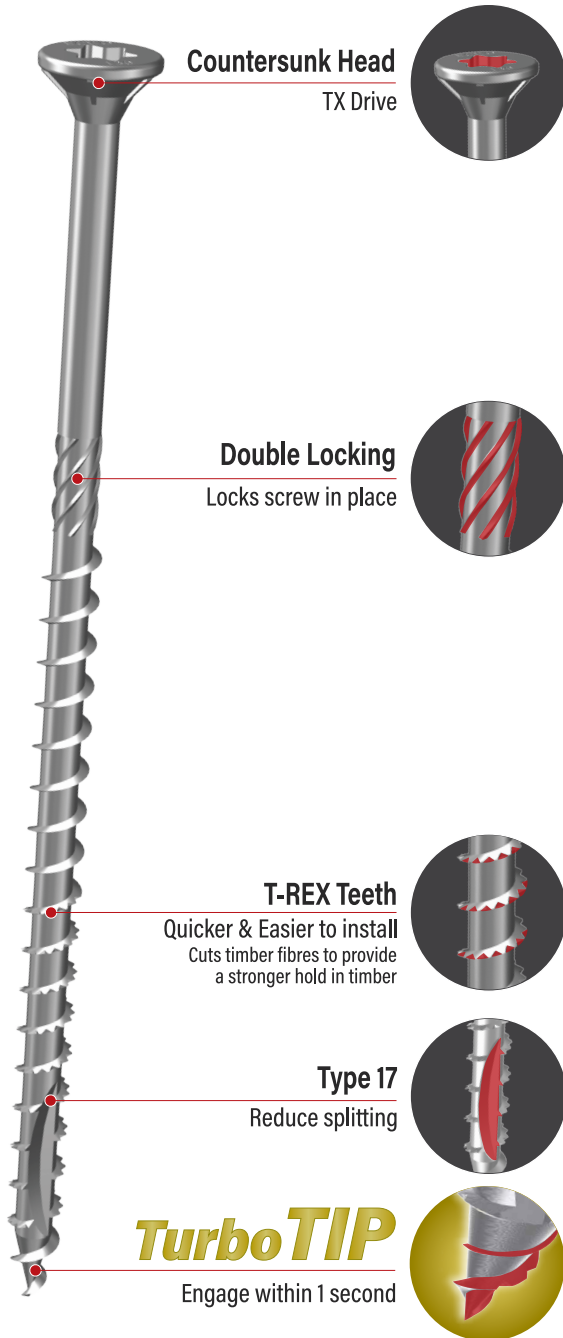

**Countersunk Head**  
TX Drive

**Double Locking**  
Locks screw in place

**T-REX Teeth**  
Quicker & Easier to install  
Cuts timber fibres to provide  
a stronger hold in timber

**Type 17**  
Reduce splitting

**Turbo TIP**  
Engage within 1 second

**TECHNICAL DATA  
AVAILABLE**

**DRIVER BIT**



Excluded

**DRIVE**

M6



T30 Drive

M8



T40 Drive

M10



T50 Drive

**FINISH**



Outdoor Use



Outdoor / Sea  
Spray Zone Use

**ECKO-FRIENDLY PACKAGING**  
Recyclable



Timber construction

\*Please refer to the technical specification for fastener requirements or installation manual for each specific application you are working with.

# T-REX17® Construction Screws

Countersunk Head, TX Drive - OutDoor XGuard & 304 Stainless Steel

OutDoor XGuard - Outdoor Use					
Diameter	Length (mm)	Product Code	Drive	PCS / Pack	Pack / Outer
M8	100	TCCM8100L-50	T40 Drive	50	18
	120	TCCM8120L-50	T40 Drive	50	12
	140	TCCM8140L-50	T40 Drive	50	12
M10	100	TCCM10100L-50	T50 Drive	50	6
	120	TCCM10120L-50	T50 Drive	50	6
	140	TCCM10140L-50	T50 Drive	50	12
	160	TCCM10160L-50	T50 Drive	50	12
304 Stainless Steel - Outdoor & Sea Spray Zone Use					
Diameter	Length (mm)	Product Code	Drive	PCS / Pack	Pack / Outer
M6	60	TCCSSM660L-100	T30 Drive	100	18
	80	TCCSSM680L-100	T30 Drive	100	18
	100	TCCSSM6100L-100	T30 Drive	100	18
	120	TCCSSM6120L-100	T30 Drive	100	12
	140	TCCSSM6140L-100	T30 Drive	100	12
M8	80	TCCSSM880L-50	T40 Drive	50	12
	100	TCCSSM8100L-50	T40 Drive	50	12
	120	TCCSSM8120L-50	T40 Drive	50	12
	140	TCCSSM8140L-50	T40 Drive	50	12
	160	TCCSSM8160L-50	T40 Drive	50	10
	180	TCCSSM8180L-50	T40 Drive	50	10
	200	TCCSSM8200L-50	T40 Drive	50	10

## SCREW DURABILITY TABLE

ECKO Construction Screws OutDoor XGuard

Building Location	Cladding that acts as bracing (50 year durability)	Non-Structural Cladding (15 year durability)	Framing in "Closed" areas (including roof spaces)
Zone B & C	304 Stainless Steel	OutDoor XGuard	Mild Steel
Zone D	304 Stainless Steel	OutDoor XGuard	Mild Steel
Building Location	Framing in "Sheltered" areas		Framing in "Exposed" areas
Zone B & C	OutDoor XGuard		304 Stainless Steel
Zone D	OutDoor XGuard		304 Stainless Steel

ECKO T-REX17® Construction Screws are manufactured with OutDoor XGuard coating for use in sheltered conditions as per **NZS3604 Corrosion Zone Table 4.3 Nail and Screw use**.

# Button Head Metal Screws

Button Head, TX Drive - C4 Galvanised

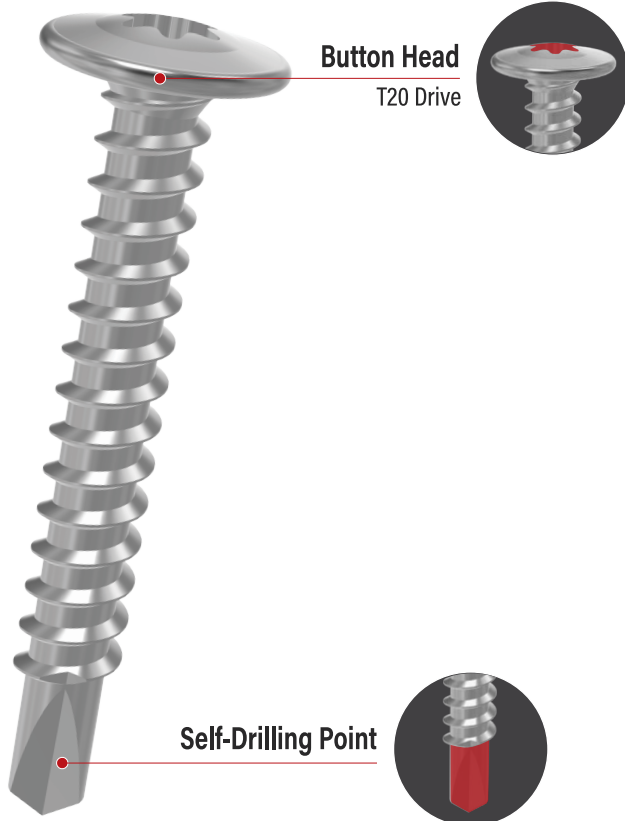

**DRIVE**

T20 Drive

**DRIVER BIT**

Included in each packet

**FINISH**

Outdoor Use

**APPLICATION**

For Metal

**ECKO-FRIENDLY PACKAGING**  
Recyclable



Steel I stud

\*Please refer to the technical specification for fastener requirements or installation manual for each specific application you are working with.

C4 Galvanised - Outdoor Use					
Diameter	Length (mm)	Product Code	Drive	PCS / Pack	Pack / Outer
8G	16	BUTC48G16-200	T20 Drive	200	6
	20	BUTC48G20-200	T20 Drive	200	6
	30	BUTC48G30-200	T20 Drive	200	6

# Wafer Head Metal Screws

Wafer Head, TX Drive - C4 Galvanised

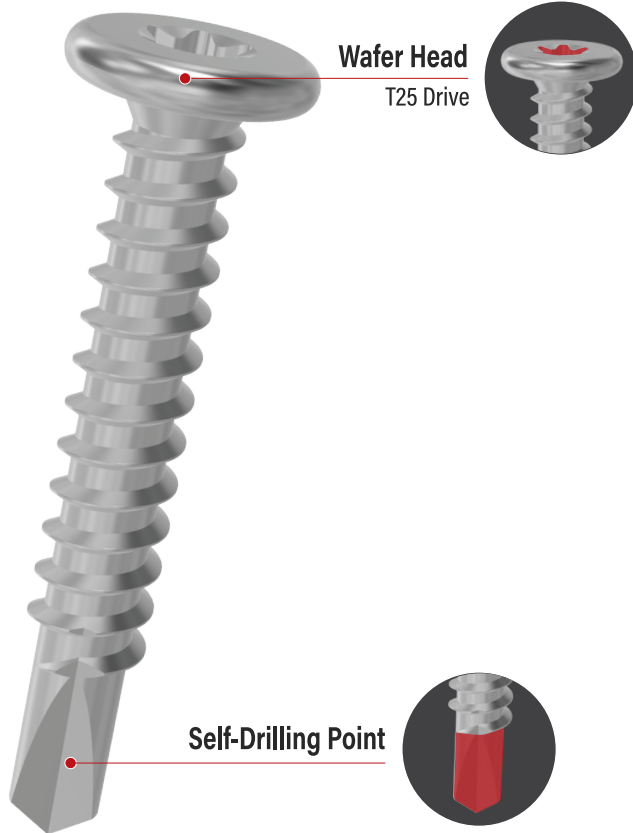

**DRIVE**

T25 Drive

**DRIVER BIT**

Included in each packet

**FINISH**

Outdoor Use

**APPLICATION**

For Metal

**ECKO-FRIENDLY PACKAGING**  
Recyclable



Steel I stud

\*Please refer to the technical specification for fastener requirements or installation manual for each specific application you are working with.

C4 Galvanised - Outdoor Use					
Diameter	Length (mm)	Product Code	Drive	PCS / Pack	Pack / Outer
10G	16	W AFC410G16-100	T25 Drive	100	6
	20	W AFC410G20-100	T25 Drive	100	6
	30	W AFC410G30-100	T25 Drive	100	6

# Countersunk Head Winged Metal Screws

Countersunk Head, TX Drive - C4 Galvanised

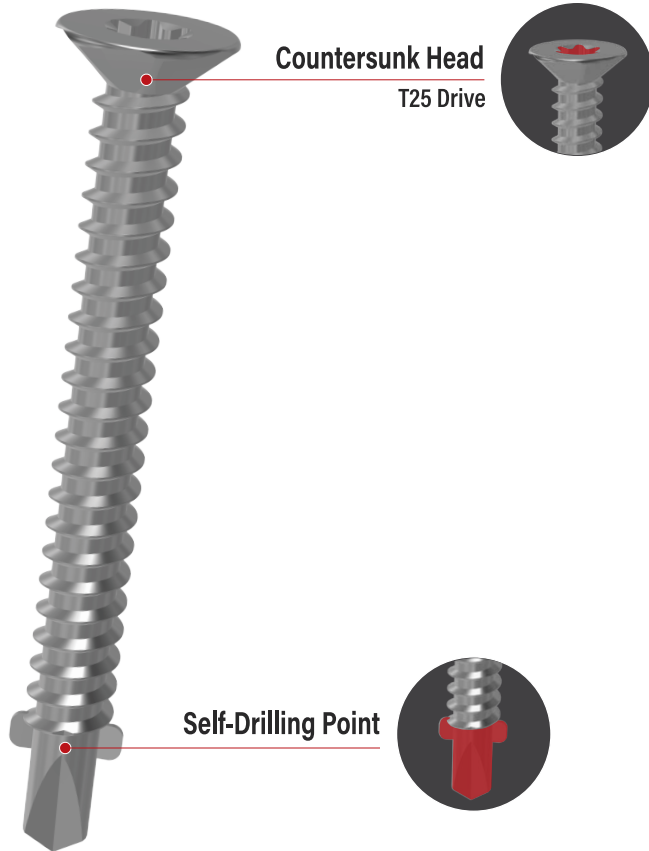

**DRIVE**

T25 Drive

**DRIVER BIT**

Included in each packet

**FINISH**

Outdoor Use

**APPLICATION**

Timber to Metal

**ECKO-FRIENDLY PACKAGING**  
Recyclable



\*Please refer to the technical specification for fastener requirements or installation manual for each specific application you are working with.

C4 Galvanised - Outdoor Use					
Diameter	Length (mm)	Product Code	Drive	PCS / Pack	Pack / Outer
10G	35	WINC410G35-100	T25 Drive	100	6
	40	WINC410G40-100	T25 Drive	100	6
	45	WINC410G45-100	T25 Drive	100	6
	55	WINC410G55-100	T25 Drive	100	6
	65	WINC410G65-100	T25 Drive	100	6

# Winged CSK Head Deep Drilling Screws

Countersunk Head, TX Drive - OutDoor XGuard



Countersunk Head  
T30 Drive

Winged Deep Drilling  
Up to 12mm steel

**DRIVE**

T30 Drive

**DRIVER BIT**

Included in each packet

**FINISH**

Outdoor Use

**APPLICATION**

Timber to Metal

**ECKO-FRIENDLY PACKAGING**  
Recyclable

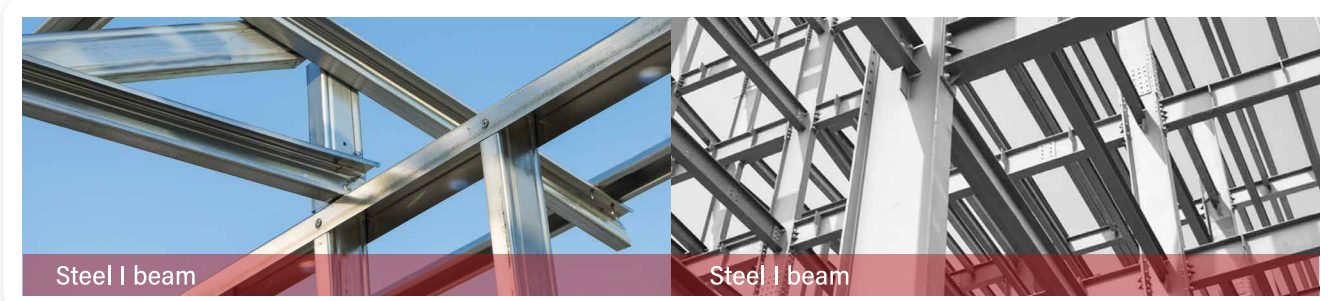

Steel I beam

Steel I beam

\*Please refer to the technical specification for fastener requirements or installation manual for each specific application you are working with.

OutDoor XGuard - Outdoor Use					
Diameter	Length (mm)	Product Code	Drive	PCS / Pack	Pack / Outer
14G	65	WINC414G65-100	T30 Drive	100	6
	80	WINC414G80-100	T30 Drive	100	5
	100	WINC414G100-100	T30 Drive	100	5

# Hex Head No NEO Washer Wood Screws

Hex Head, Type 17 - Yellow Zinc



Hex Head

Type 17

Reduce splitting

DRIVE



Hex Drive

SOCKET DRIVER BIT



Included in each packet

FINISH



Indoor Use

APPLICATION



For Timber

ECKO-FRIENDLY PACKAGING

Recyclable



HotEdge

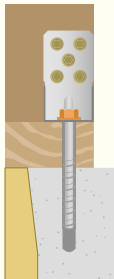

9kN Truss Fixing



16kN Truss Fixing

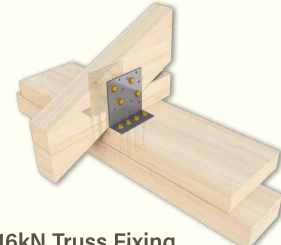

Commonly used for brackets, especially in metal-to-wood and wood-to-wood connections. We have a wide range of high-quality timber brackets available to suit your project needs. To explore the full range of options, please check out our bracket series in the catalogue for more details on sizes, and specifications.

\*Please refer to the technical specification for fastener requirements or installation manual for each specific application you are working with.

Yellow Zinc - Indoor Use						
Diameter	Length (mm)	Product Code	Drive	Thread	PCS / Pack	Pack / Outer
12G	35	HXYZT12G35-200	5/16 Hex Head no NEO	Standard	200	6
	35	HXYZT14G35-100	3/8 Hex Head no NEO	Standard	100	6
14G	35	HXYZT14G35-200	3/8 Hex Head no NEO	Standard	200	6
	75	HXYZT14G75-100	3/8 Hex Head no NEO	Standard	100	6

# Hex Head No NEO Washer Wood Screws

Hex Head, Type 17 - C4 Galvanised & 316 Stainless Steel



Hex Head

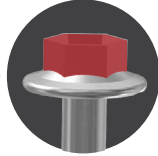

**T-REX Teeth**  
Quicker & Easier to install  
Cuts timber fibres to provide  
a stronger hold in timber



**Type 17**  
Reduce splitting



DRIVE



Hex Drive

SOCKET DRIVER BIT



Included in each packet

FINISH



Outdoor Use



Outdoor / Sea  
Spray Zone Use

APPLICATION



Timber / Brackets / Boxing

ECKO-FRIENDLY PACKAGING

Recyclable



C4 Galvanised - Outdoor Use						
Diameter	Length (mm)	Product Code	Drive	Thread	PCS / Pack	Pack / Outer
12G	25	HXC4T12G25-100	5/16 Hex Head no NEO	Standard	100	6
	35	HXC4T12G35-200	5/16 Hex Head no NEO	Standard	200	6
	40	HXC4T12G40-100	5/16 Hex Head no NEO	Standard	100	6
	45	HXC4T12G45-100	5/16 Hex Head no NEO	Standard	100	6
	50	HXC4T12G50-100	5/16 Hex Head no NEO	Standard	100	6
14G	35	HXC4T14G35-100	3/8 Hex Head no NEO	Standard	100	6
	35	HXC4T14G35-200	3/8 Hex Head no NEO	Standard	200	6
	50	HXC4T14G50-100	3/8 Hex Head no NEO	Standard	100	6
	65	HXC4T14G65-100	3/8 Hex Head no NEO	Standard	100	5
	75	HXC4T14G75-100	3/8 Hex Head no NEO	Standard	100	5
	90	HXC4T14G90-100	3/8 Hex Head no NEO	Standard	100	5
	100	HXC4T14G100-100	3/8 Hex Head no NEO	Standard	100	5
316 Stainless Steel - Outdoor & Sea Spray Zone Use						
Diameter	Length (mm)	Product Code	Drive	Thread	PCS / Pack	Pack / Outer
12G	25	HX316T12G25-100	5/16 Hex Head no NEO	T-REX Teeth	100	6
	35	HX316T12G35-100	5/16 Hex Head no NEO	T-REX Teeth	100	6
	50	HX316T12G50-100	5/16 Hex Head no NEO	T-REX Teeth	100	6
	65	HX316T12G65-100	5/16 Hex Head no NEO	T-REX Teeth	100	5
	75	HX316T12G75-100	5/16 Hex Head no NEO	T-REX Teeth	100	5
14G	25	HX316T14G25-100	3/8 Hex Head no NEO	T-REX Teeth	100	6
	35	HX316T14G35-100	3/8 Hex Head no NEO	T-REX Teeth	100	6
	50	HX316T14G50-100	3/8 Hex Head no NEO	T-REX Teeth	100	5
	65	HX316T14G65-100	3/8 Hex Head no NEO	T-REX Teeth	100	5
	75	HX316T14G75-100	3/8 Hex Head no NEO	T-REX Teeth	100	5
	90	HX316T14G90-100	3/8 Hex Head no NEO	T-REX Teeth	100	5
	100	HX316T14G100-100	3/8 Hex Head no NEO	T-REX Teeth	100	5
	125	HX316T14G125-100	3/8 Hex Head no NEO	T-REX Teeth	100	5

# Hex Head NEO Washer Wood Screws

Hex Head, Type 17 - C4 Galvanised



**HEAD TYPE**  
Hex Head with NEO washer

**SOCKET DRIVER BIT**

Included in each packet

**FINISH**

Outdoor Use

**APPLICATION**

For Timber

**ECKO-FRIENDLY PACKAGING**  
Recyclable



Roofing

\*Please refer to the technical specification for fastener requirements or installation manual for each specific application you are working with.

C4 Galvanised - Outdoor Use					
Diameter	Length (mm)	Product Code	Drive	PCS / Pack	Pack / Outer
10G	25	HXC4T10G25N-50	5/16 Hex Head NEO washer, driver bit excluded	50	6
	25	HXC4T10G25N-100	5/16 Hex Head NEO washer	100	6
12G	35	HXC4T12G35N-50	5/16 Hex Head NEO washer, driver bit excluded	50	6
	35	HXC4T12G35N-100	5/16 Hex Head NEO washer	100	6
	45	HXC4T12G45N-50	5/16 Hex Head NEO washer, driver bit excluded	50	6
	45	HXC4T12G45N-100	5/16 Hex Head NEO washer	100	6
	50	HXC4T12G50N-50	5/16 Hex Head NEO washer, driver bit excluded	50	6
	50	HXC4T12G50N-100	5/16 Hex Head NEO washer	100	6
	65	HXC4T12G65N-25	5/16 Hex Head NEO washer, driver bit excluded	25	6
	65	HXC4T12G65N-100	5/16 Hex Head NEO washer	100	6
	65	HXC4T12G65N-200	5/16 Hex Head NEO washer	200	5
	75	HXC4T12G75N-25	5/16 Hex Head NEO washer, driver bit excluded	25	6
75	HXC4T12G75N-100	5/16 Hex Head NEO washer	100	6	
14G	55	HXC4T14G55N-100	3/8 Hex Head NEO washer	100	6
	65	HXC4T14G65N-100	3/8 Hex Head NEO washer	100	6
	75	HXC4T14G75N-25	3/8 Hex Head NEO washer, driver bit excluded	25	6
	75	HXC4T14G75N-100	3/8 Hex Head NEO washer	100	6
	75	HXC4T14G75N-200	3/8 Hex Head NEO washer	200	4
	90	HXC4T14G90N-25	3/8 Hex Head NEO washer, driver bit excluded	25	6
	90	HXC4T14G90N-100	3/8 Hex Head NEO washer	100	5
	100	HXC4T14G100N-25	3/8 Hex Head NEO washer, driver bit excluded	25	6
	100	HXC4T14G100N-100	3/8 Hex Head NEO washer	100	5
	100	HXC4T14G100N-200	3/8 Hex Head NEO washer	200	4

# Hex Head NEO Washer Metal Screws

Hex Head, Self-Drilling Point - C4 Galvanised



**Hex Head**  
with NEO washer

**Self-Drilling Point**

## HEAD TYPE

Hex Head with  
NEO washer



## SOCKET DRIVER BIT



Included in each packet

## FINISH



Outdoor Use

## APPLICATION



For Metal

## ECKO-FRIENDLY PACKAGING

Recyclable



Roofing

\*Please refer to the technical specification for fastener requirements or installation manual for each specific application you are working with.

C4 Galvanised - Outdoor Use					
Diameter	Length (mm)	Product Code	Drive	PCS / Pack	Pack / Outer
10G	16	HXC4S10G16N-50	5/16 Hex Head NEO washer	50	6
	20	HXC4S12G20N-50	5/16 Hex Head NEO washer	50	6
	25	HXC4S12G25N-50	5/16 Hex Head NEO washer	50	6
12G	35	HXC4S12G35N-50	5/16 Hex Head NEO washer	50	6
	45	HXC4S12G45N-50	5/16 Hex Head NEO washer	50	6
	55	HXC4S12G55N-50	5/16 Hex Head NEO washer	50	6
	65	HXC4S12G65N-100	5/16 Hex Head NEO washer	100	6
	65	HXC4S14G65N-100	3/8 Hex Head NEO washer	100	6
14G	75	HXC4S14G75N-100	3/8 Hex Head NEO washer	100	6

# T-REX17® WanzFit® Pan Head Screws

Pan Head, TX Drive - 304 Stainless Steel

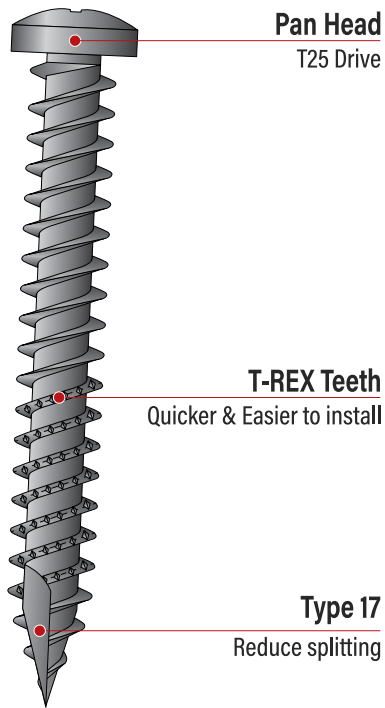

## DRIVE



T25 Drive

## DRIVER BIT



Included in each packet

## FINISH



Outdoor / Sea  
Spray Zone Use

## ECKO-FRIENDLY PACKAGING

Recyclable



## APPLICATION

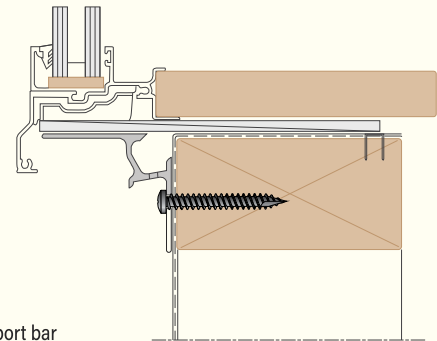

Sill support bar

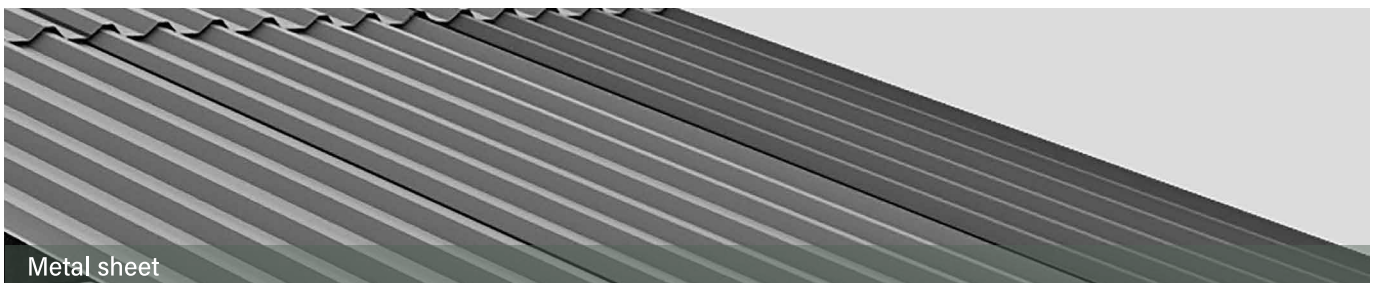

\*Please refer to the technical specification for fastener requirements or installation manual for each specific application you are working with.

304 Stainless Steel - Outdoor & Sea Spray Zone Use					
Diameter	Length (mm)	Product Code	Drive	PCS / Pack	Pack / Outer
10G	50	PH30410G50-300	T25 Drive	300	5



**Note:** *The WANZ sill support bars, as described on the Components page (Page 37) are designed to fit a number of different claddings and circumstances. Selection of the correct bar, and its installation, is important. Please refer to the following to assist in the selection.*

**COMMENT**

Support bars and mechanisms are rated for their capacity to support the total weight of a joinery unit when installed at given offsets from the frame depending on *cladding* type. Designers select the an appropriate complying support mechanism for the joinery weight. Manufacturers provide build-in instructions for support bars and mechanisms.

**Fixing Options;**

- i. The generic fixing method into timber is 10g x 50mm pan head stainless steel screws, positioned at each end of the bar and at a maximum of 300mm centres between.
- ii. When fixing to concrete, the Heavy-Duty bars must be used. The same screws and fixing centres, as noted above, apply but the screws would be driven into nylon plugs or similar.
- iii. For concrete the screws may be substituted for 6mm masonry anchors, at the same centres. However, in order to achieve the required edge clearance that these fasteners require, the Heavy-Duty bar must be re-drilled to suit.

# Self-Tapping Screws

Pan Head, Square Drive - 304 Stainless Steel

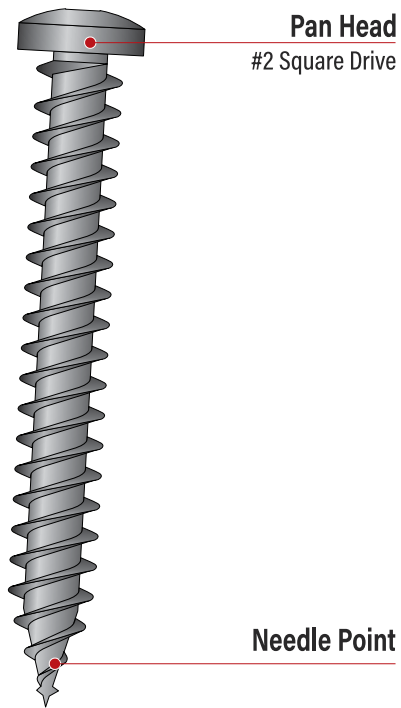

**DRIVE**

#2 Square Drive

**DRIVER BIT**

Included in each packet

**FINISH**

Outdoor / Sea  
Spray Zone Use

**ECKO-FRIENDLY PACKAGING**  
Recyclable

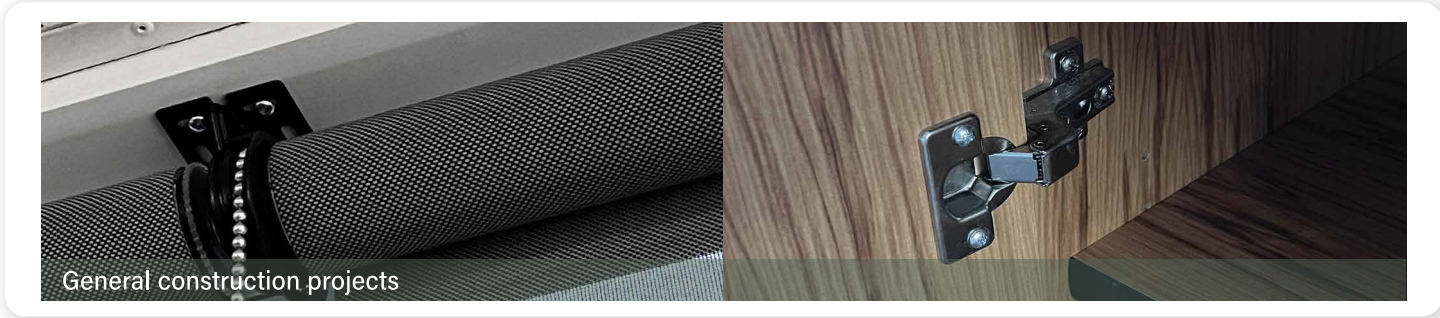

General construction projects







\*Please refer to the technical specification for fastener requirements or installation manual for each specific application you are working with.

304 Stainless Steel - Outdoor & Sea Spray Zone Use					
Diameter	Length (mm)	Product Code	Drive	PCS / Pack	Pack / Outer
8G	20	PH3048G20-200	#2 Square Drive	200	6
	25	PH3048G25-200	#2 Square Drive	200	6
	32	PH3048G32-200	#2 Square Drive	200	6
	40	PH3048G40-200	#2 Square Drive	200	6
	50	PH3048G50-200	#2 Square Drive	200	6

# Driver Bits & Accessories

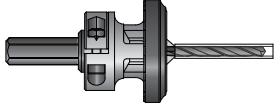
Driver Bit Sets, Driver Bit Keyring Holder, Carpenter Pencil

Purchase per Outer

Internal Hex Drive - 3pcs per pack Purchase per Outer				
				
Product Code	Drive	To Suit	Pcs / Pack	Pack / Outer
A-HEX5-3	Hex 5mm	ECKO 14g batten screw	3	8
TX Drive - 3pcs per Pack Purchase per Outer				
				
Product Code	Drive	To Suit	Pcs / Pack	Pack / Outer
A-TX15-3	T15	ECKO 8g JoltScrew	3	8
A-TX20-3	T20	ECKO 10g decking screw cylindrical head. 8g TimbaTX® Screw. 8g Button Head SDS	3	8
A-TX25-3	T25	ECKO 10g decking screw CSK head, oval head, 10g & 12g trim head. 10g purlin screw. 10g TimbaTX® screw. 10g wafer head SDS, 10g winged SDS	3	8
A-TX30-3	T30	ECKO M6 construction screw	3	8
A-TX40-3	T40	ECKO M8 construction screw, 14g batten screw	3	8
A-TX50-3	T50	ECKO M10 construction screw	3	8
Socket Driver Bit - 2pcs per pack Purchase per Outer				
				
Product Code	Drive	To Suit	Pcs / Pack	Pack / Outer
A-HEX516-2	5/16 Hex	ECKO 10g & 12g hex head SDS & wood screw	2	8
A-HEX38-2	3/8 Hex	ECKO 14g hex head SDS & wood screw	2	8
Adjustable Countersunk Drill Bit - 1pc per pack Purchase per Outer				
				
			Includes 	
Product Code	Drive	Description	Pcs / Pack	Pack / Outer
A-CSKBIT1012G	10-12G	Includes 1 x allen key & 2 x drill bits	1	6
Driver Bit Keyring Holder Purchase per Outer				
	Product Code	Description	Pcs / Outer	
	A-BITHOLDER	To suit 1/4 inch hex shank. Hex sockets are easy to hold and change bits. Made of carbon steel and aluminium for good durability, light weight and sturdiness.  6pc drill driver bit holders in different colours. Carabiner with twist and spring lock.	10	
Carpenter Pencil Set Purchase per Outer				
	Product Code	Description	Pcs / Pack / Outer	
	EC-CPENCIL	Includes 1 x carpenter pencil with a lead + 6 replacement leads (4 x standard, 2 x yellow leads 2.80mm) in each set.  Sharpener included. Ergonomic handling. Quick-Release clip for pocket & belt.	10 / 5 / Outer	